

Pesticide Safety

A Reference Manual for Private Applicators

SECOND EDITION

University of California
Statewide Integrated Pest Management Program
IPM Education and Publications
Division of Agriculture and Natural Resources
Publication 3383

2006

Acknowledgements

Authors: Patrick O'Connor-Marer and Susan Cohen.

This 2006 Second Edition was based on an earlier version authored by Patrick O'Connor-Marer, formerly Pesticide Training Coordinator, University of California. The Second Edition was completed by Susan Cohen, Senior Writer, IPM Education and Publications, University of California Statewide IPM Program. Mary Louise Flint, Director, IPM Education and Publications, UC Statewide IPM Program, UC Davis was Technical Editor on the Second Edition.

This manual was produced by the University of California Statewide Integrated Pest Management Program, Richard Roush, Director, through a Memorandum of Understanding between the University of California and the California Department of Pesticide Regulation.

Production (Second Edition)

Design and Production

Coordination:

Chris O'Connor (based on First Edition design by
Pat O'Connor-Marer and Diane Clarke)

Photographs:

Jack Kelly Clark

Drawings:

David Kidd, Javier Juarez, U.S. EPA – *Applying Pesticides Correctly, Protect Yourself from Pesticides, and Avoiding Heat Stress* (pages 1, 10, 11, 12, 29, 53, 58, 67, 75, 101, 107, and 108)

Reviewers and Contributors (Second Edition)

The following people assisted by reviewing the manuscript and providing additional information:

- V. Acosta, California Department of Pesticide Regulation, Sacramento
- C. Andrews, California Department of Pesticide Regulation, Sacramento
- S. Edmiston, California Department of Pesticide Regulation, Sacramento
- M. Flint, UC Statewide IPM Program, Davis
- A. Gallo, California Department of Pesticide Regulation, Sacramento
- R. Hirose, California Department of Pesticide Regulation, Sacramento
- J. Inouye, California Department of Pesticide Regulation, Sacramento
- R. Melnicoe, UC Pesticide Information and Coordination, Davis
- P. O'Connor-Marer, Roseville
- S. Scheer, Sutter County Department of Agriculture, Yuba City
- E. Smith, California Department of Pesticide Regulation, Sacramento
- K. Solari, California Department of Pesticide Regulation, Sacramento
- M. Takeda, California Department of Pesticide Regulation, Sacramento

Pesticide Safety

A Reference Manual for Private Applicators

SECOND EDITION

University of California
Statewide Integrated Pest Management Program
IPM Education and Publications
Division of Agriculture and Natural Resources
Publication 3383

2006

Funding for the second edition of this manual was provided in part through an agreement between the California Department of Pesticide Regulation and The Regents of the University of California, Agreement Number 05-0093C, and through the Extension Service, U.S. Department of Agriculture, under special project Section 3(d), Pesticide Safety Education Program.

Funding for the first edition of this manual was provided in part by the Extension Service, U.S. Department of Agriculture, under special project Section 3(d), Pesticide Applicator Training, and through a National Institute for Occupational Safety and Health cooperative agreement number U 07/CCU 9066162-02 with the UC Agricultural Health and Safety Center at Davis.

For information about ordering this publication, contact

University of California
Agriculture and Natural Resources
Communication Services
6701 San Pablo Avenue, 2nd Floor
Oakland, California 94608-1239

Telephone 1-800-994-8849
(510) 642-2431
FAX (510) 643-5470
E-mail: damrcs@ucdavis.edu
Visit the ANR Communication Services Web site at <http://anrcatalog.ucdavis.edu>

Publication 3383



This publication has been peer reviewed for technical accuracy by University of California scientists and other qualified professionals. This review process was managed by the ANR Associate Editor for Pest Management.

ISBN-13: 978-1-879906-83-9
ISBN-10: 1879906-83-X

©1998, 2006 by the Regents of the University of California
Division of Agriculture and Natural Resources

All rights reserved.

No part of this publication may be reproduced, stored in a retrieval system, or transmitted, in any form or by any means, electronic, mechanical, photocopying, recording, or otherwise, without the written permission of the publisher and the authors.

♻️ Printed in the United States of America on recycled paper.

The University of California prohibits discrimination or harassment of any person on the basis of race, color, national origin, religion, sex, gender identity, pregnancy (including childbirth, and medical conditions related to pregnancy or childbirth), physical or mental disability, medical condition (cancer-related or genetic characteristics), ancestry, marital status, age, sexual orientation, citizenship, or status as a covered veteran (covered veterans are special disabled veterans, recently separated veterans, Vietnam era veterans, or any other veterans who served on active duty during a war or in a campaign or expedition for which a campaign badge has been authorized) in any of its programs or activities. University policy is intended to be consistent with the provisions of applicable State and Federal laws. Inquiries regarding the University's nondiscrimination policies may be directed to the Affirmative Action/Staff Personnel Services Director, University of California, Agriculture and Natural Resources, 1111 Franklin St., 6th Floor, Oakland, CA 94612-3550, (510) 987-0096. For information about ordering this publication, telephone 1-800-994-8849.

To simplify information, trade names of products have been used. No endorsement of named or illustrated products is intended, nor is criticism implied of similar products that are not mentioned or illustrated.

6m-rep-2/10-SC/CO

second printing, 2010

Acknowledgements

Authors: Patrick O'Connor-Marer and Susan Cohen.

This 2006 Second Edition was based on an earlier version authored by Patrick O'Connor-Marer, formerly Pesticide Training Coordinator, University of California. The Second Edition was completed by Susan Cohen, Senior Writer, IPM Education and Publications, University of California Statewide IPM Program. Mary Louise Flint, Director, IPM Education and Publications, UC Statewide IPM Program, UC Davis was Technical Editor on the Second Edition.

This manual was produced by the University of California Statewide Integrated Pest Management Program, Richard Roush, Director, through a Memorandum of Understanding between the University of California and the California Department of Pesticide Regulation.

Production (Second Edition)

Design and Production

Coordination:

Chris O'Connor (based on First Edition design by
Pat O'Connor-Marer and Diane Clarke)

Photographs:

Jack Kelly Clark

Drawings:

David Kidd, Javier Juarez, U.S. EPA – *Applying Pesticides Correctly, Protect Yourself from Pesticides*, and *Avoiding Heat Stress* (pages 1, 10, 11, 12, 29, 53, 58, 67, 75, 101, 107, and 108)

Reviewers and Contributors (Second Edition)

The following people assisted by reviewing the manuscript and providing additional information:

- V. Acosta, California Department of Pesticide Regulation, Sacramento
- C. Andrews, California Department of Pesticide Regulation, Sacramento
- S. Edmiston, California Department of Pesticide Regulation, Sacramento
- M. Flint, UC Statewide IPM Program, Davis
- A. Gallo, California Department of Pesticide Regulation, Sacramento
- R. Hirose, California Department of Pesticide Regulation, Sacramento
- J. Inouye, California Department of Pesticide Regulation, Sacramento
- R. Melnicoe, UC Pesticide Information and Coordination, Davis
- P. O'Connor-Marer, Roseville
- S. Scheer, Sutter County Department of Agriculture, Yuba City
- E. Smith, California Department of Pesticide Regulation, Sacramento
- K. Solari, California Department of Pesticide Regulation, Sacramento
- M. Takeda, California Department of Pesticide Regulation, Sacramento

The following people assisted by providing technical support or advice:

- S. Dreistradt, Statewide IPM, University of California, Davis
- R. Galin, Statewide IPM, University of California, Davis
- E. Johnson, Statewide IPM, University of California, Davis
- A. Senuta, ANR Communication Services, University of California, Davis
- K. Stewart, Statewide IPM, University of California, Davis
- L. Strand, Statewide IPM, University of California, Davis

Technical Committee and Reviewers (First Edition)

- D. Alvernaz, Grower, Yolo and Sutter Counties
- G. Alvernaz, Grower, Yolo and Sutter Counties
- C. Andrews, California Department of Pesticide Regulation, Sacramento
- H. Bennett, Pesticide Applicator's Professional Association, Wickenburg, Arizona
- K. Bishop, Trinity County Department of Agriculture
- L. Correia, Sonoma County Department of Agriculture
- K. Crum, California Agricultural Pest Control Advisers Association, Sacramento
- D. Edwards, Fresno County Department of Agriculture
- R. Hirose, California Department of Pesticide Regulation, Sacramento
- J. Karl, Santa Barbara County Department of Agriculture
- D. Lynch, California Department of Pesticide Regulation, Fresno
- L. Mendoza, Butte County Department of Agriculture
- D. Merkley, California Department of Pesticide Regulation, Sacramento
- E. Smith, California Department of Pesticide Regulation, Sacramento
- M. Takeda, California Department of Pesticide Regulation, Sacramento

CONTENTS

Introduction – 1

- How to Use This Booklet – 2
- Farm Owners and Managers – 2
- Farm Employees – 3
- A Farm Profile – 4

Chapter 1: The Pesticide Label – 21

- Learn to Use Pesticide Labels – 22
 - When to Read the Pesticide Label – 22
 - Parts of the Pesticide Label – 23
- Worker Protection Information – 26
- Pesticide Product Registration – 28
 - Types of Pesticide Product Registration – 29
 - Material Safety Data Sheets – 30
 - Review Questions – 35

Chapter 2: Mixing and Applying Pesticides – 38

- Mixing Pesticides – 38
 - Steps for Mixing – 42
 - Applying Pesticides Effectively – 43
 - Selecting Application Equipment – 43
 - Safe Application Techniques – 44
 - Pesticide Drift – 46
 - Timing Your Applications for Effective Pest Control – 47
- Equipment Calibration – 48
 - Calibrating Your Application Equipment – 49
 - Calibrating Liquid Application Equipment – 49
 - Tank Capacity – 51
 - Speed of Travel – 52
 - Flow Rate – 53
 - Width of Spray Swath – 55
 - Determining the Area to Be Treated – 56
 - Determining the Amount of Pesticide to Use – 56
 - Changing Sprayer Output – 56
 - Calibrating Granular Applicators – 57
 - Travel Speed – 58
 - Rate of Output – 58
 - Measuring Swath Width – 59
 - Determining Application Rate – 59
 - Review Questions – 60

Chapter 3: Recognizing and Avoiding Pesticide Hazards – 63

- Pesticide Residues – 64
- How People are Exposed to Pesticides – 64
 - Effects of Exposure – 65
 - Ways to Prevent Exposure – 66
- How Environmental Contamination Occurs – 70
 - Groundwater Contamination – 70
 - Surface Water Contamination – 72
- Pesticide Impact on Nontarget Organisms – 72
- Handling Pesticide Containers – 74
- Postapplication Cleanup – 74
- Review Questions – 76

Chapter 4: Pesticide Emergencies – 78

- First Aid – 78
 - Pesticides on Your Skin or Clothing – 79
 - First Aid for Skin Exposure – 79
 - Pesticides in Your Eyes – 80
 - First Aid for Eye Exposure – 80
 - Inhaled Pesticides – 81
 - First Aid for Pesticide Inhalation – 81
 - Swallowed Pesticides – 82
 - First Aid for Swallowed Pesticides – 82
 - Pesticide Leaks and Spills – 82
 - Cleaning up Pesticide Leaks or Spills – 83
 - Pesticide Fires – 84
 - How to Deal with a Pesticide Fire – 84
- Misapplication of Pesticides – 85
 - Incorrect Amount of Pesticide Used – 85
 - Application of the Wrong Pesticide – 86
 - Pesticides Applied to the Wrong Site or Crop – 86
 - Review Questions – 87

Answers to Review Questions – 88

Appendix – 89

- Checklist for Planning a Pesticide Application – 90
- Pesticide Information Resources – 91
- Pesticide Poisoning Emergencies – 96
- Useful Resources for Pesticide Handling and Pest Management – 97
- Pesticide Handler Safety Training Record – 98 SAMPLE
- Criteria for Fieldworker Training – 99
- Fieldworker Pesticide Safety Training Record – 100 SAMPLE
- Training and Instructions for Early-Entry Workers – 101
- California Restricted-Entry Intervals – 102
- Organophosphate and N-Methyl Carbamate Pesticides – 103
- Production Agriculture Monthly Pesticide Use Report – 104
- Pesticide Safety Information Series – 105
- Procedures for Triple Rinsing Pesticide Containers – 106
- Avoiding Heat Related Illness – 107
- Useful Conversion Factors for Calibration – 109

Glossary – 110

Index – 116

INTRODUCTION

Pests have caused problems for farmers since the beginning of agriculture thousands of years ago. Weeds, insects, nematodes, and plant diseases are troublesome pests that can drastically reduce agricultural production, sometimes creating famines in which millions of people have starved. Today, crop destruction caused by pests threatens the viability of your farming operation by reducing your farm income.

During the past half-century, scientific advances have provided you with new and powerful pest management tools. Most important among these tools are *chemical pesticides*. To protect your crops—even if you are farming organically—you sometimes must use pesticides. While pesticides have added to your agricultural productivity, they have also created serious new environmental and health concerns for society.

All pesticides are toxic. They must be toxic to kill the pests you are trying to control. Some pesticides are more toxic than others, however. The hazard to you and

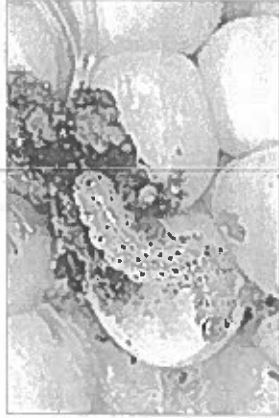

Pests, such as this corn earworm, *Helicoverpa zea*, can drastically reduce your agricultural production and the quality of your crops.

others when you use pesticides is a combination of this toxicity and the amount of exposure. Exposure can take place through several routes—your skin, eyes, mouth, and lungs—and the route of exposure may influence the degree of hazard.

Nearly a century ago, state and federal governments recognized that pesticides, although necessary for many types of pest management programs, had the potential to cause serious injury to people and cause environmental disasters. At that time, government agencies began regulating pesticide production and use. The State of California is a pioneer in pesticide regula-

tion and today has the most stringent pesticide regulatory program in the nation.

As a farmer in California, you are required to *know, understand, and follow* the federal, state, and local pesticide regulations if any pesticides are used on your farm. Obtain a copy of *Pesticide Safety Information Series A-1* through *A-11* from your county Agricultural Commissioner's office for a summary of worker safety and pest control operation laws and regulations. You must also *report* every agricultural use of pesticides to your agricultural commissioner on a monthly basis (see appendix for an example of the *Monthly Pesticide Use Report* form). In addition, federal and state laws require that anyone using restricted-use pesticides be a *certified applicator*. Even



You must follow all state, federal, and local laws when using pesticides. Remember: the pesticide label is the law.

An index of all the *Pesticide Safety Information Series* leaflets can be found in the appendix page 105

if you hire a custom (commercial) applicator, you must be certified if restricted materials are applied on your farm.

Two types of certification are available to applicators in California: *Commercial Applicator Certification* and *Private Applicator Certification*. All growers whose property is treated with restricted-use pesticides must be certified as a private applicator. This certification is also needed by farm employees who will be *training* pesticide handlers or fieldworkers about pesticide safety. Commercial applicator certification applies to people who apply pesticides for hire in any location or use or supervise the use of restricted-use pesticides on public or private nonfarm properties.

To use restricted-use pesticides on your farm, you must demonstrate, through an examination process, that you can competently and safely handle these especially hazardous chemicals. Once you successfully pass California's *Private Applicator Certification Examination* and meet other requirements, you may be issued a permit to purchase, possess, and use restricted-use pesticides. Staff at the agricultural commissioner's

office where you receive the permit will tell you how long this permit is valid. You will need to complete six hours of continuing education or take the certification examination every three years to maintain your *Private Applicator Certification* before a new permit is issued.

California's pesticide regulatory program is actively enforced and violations can result in significant penalties. State and county agencies have the authority to deal with violators using a wide range of enforcement options. Your pesticide use permit can be revoked, your crops may be quarantined or seized, and you may be liable for criminal and civil penalties.



County Agricultural Commissioners may levy fines for many pesticide regulation violations without going through the court process. Penalties can range from \$50 to \$5,000 for each violation. Although violators can appeal the penalties, many growers have paid significant fines because they violated the laws and regulations.

HOW TO USE THIS BOOKLET

This booklet is written for California farm owners, farm managers, and certain farm employees. You will use this booklet differently depending on your type of work or pest control needs.

Farm Owners and Managers

If you are a farm owner or manager, you probably need to become a *Certified Private Applicator* in order to purchase and use restricted-use pesticides as well as to train farm employees about pesticide safety. You probably are already qualified to take the examination but would appreciate a quick review. The easiest

Farm Employees

way to do this is to complete the *Farm Profile* that begins on the next page. As you proceed, you will find references to sections in this booklet or other sources that will help you identify factors on your farm that may influence how you use pesticides.

After completing the *Profile*, answer the *Review Questions* at the end of Chapters 1 through 4. If you have no problems with these review questions, you are ready to take the *Private Applicator Certification* examination at your agricultural commissioner's office. If you have trouble with some questions, review the appropriate chapters before taking the examination.

A listing of agricultural commissioner offices is included in the appendix. Check with the agricultural commissioner's office before the expiration of your current *Restricted-Use Permit* to avoid delays between passing the *Private Applicator Certification Examination* and getting your permit. Also, counties may have different renewal time periods.

Passing the *Private Applicator Certification Examination* will qualify you to train pesticide handlers and agricultural fieldworkers at your workplace. Your employer or manager may need for you to become a *Certified Private Applicator* for this purpose. If this is the main reason you are taking this examination, skip over the *Farm Profile* section. Instead, read Chapters 1 through 4 and answer the *Review Questions* at the end of each. Once you are comfortable with this information, have your employer make arrangements for you to take the examination at the agricultural commissioner's office.

GROWERS AND FARM MANAGERS

If you need a restricted-use permit, complete the following *Farm Profile*. Then, answer the *Review Questions* at the end of Chapters 1 through 4.

FARM EMPLOYEES

To prepare for the test qualifying you to train pesticide handlers and fieldworkers, read through Chapters 1 through 4 and answer the *Review Questions* at the end of each. Do not complete the *Farm Profile*.

A FARM PROFILE

Follow each step listed on the next several pages to identify the precautions you need to consider when using *restricted-use* pesticides on your farm. If you farm at two or more locations, or if your farm has more than one type of soil or crop, complete a profile such as this for each (make additional copies of this *Profile* to suit the needs of your operation).

Once you have completed the *Profile*, use this information when you apply for your *Restricted Materials Permit* at your local county Agricultural Commissioner's office. You will find the information you have put down in this *Profile* is the information the staff at the Commissioner's office needs in order to issue your permit. Understanding this information will also help you to answer the questions on the *Private Applicator Certification Examination*.

Many of the sections provide references to sources where you can get information to complete that part of the profile. You may already know the information requested, so you won't need to look it up. If you are uncertain, check out the

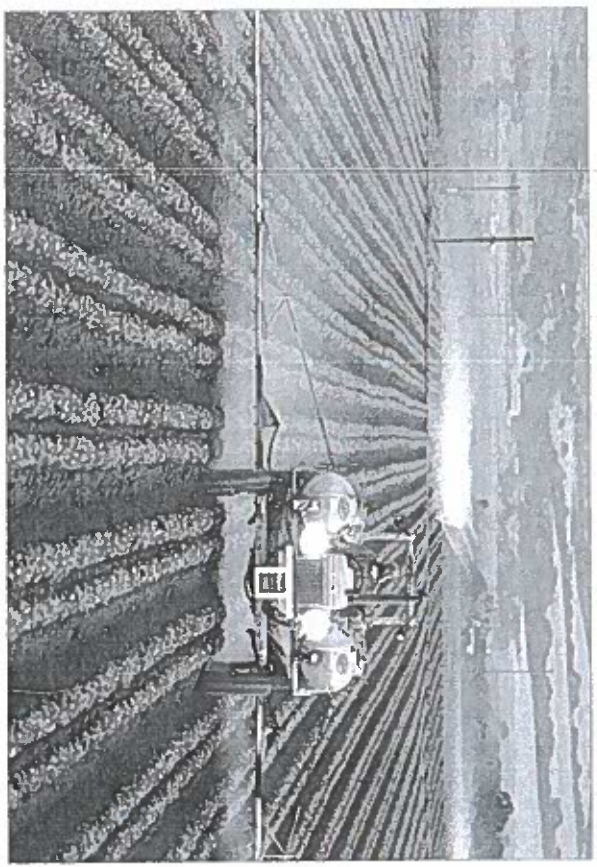

Special precautions are required when using restricted-use pesticides on your farm. Completing this Farm Profile will help you identify the hazards and conditions on your farm that will influence the ways you use pesticides there.

references. Some of this information will be in one of the four chapters of this booklet. You may also be referred to the *DPR Pesticide Safety Information Series* (PSIS), which you can obtain from the agricultural commissioner. An index of these publications is found in the appendix. Also, other useful publications are shown in the appendix.

The *Safe and Effective Use of Pesticides* is a comprehensive guide to handling and applying pesticides. Page 97 in the Appendix provides ordering information for this useful reference.



FARM INFORMATION

Name of your farm:

Owner or operator name:

Address:

Nearest crossroads:

Date this profile was prepared:

Telephone:

Town:

County:

Legal location description (use your property tax bills or your grower identification form for this information):

FARM OWNERS AND MANAGERS

Complete each section of this Profile form.

CROPS

List all crops at this location, even crops not currently being grown:

Acres of these crops:

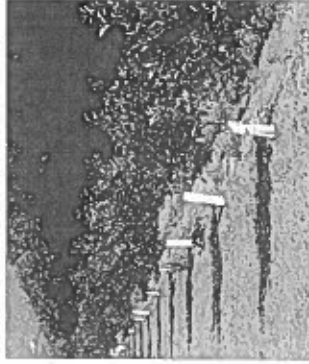

FARM EMPLOYEES

Skip to page 21 unless you will be obtaining a Restricted-Use Permit.

PEST MONITORING

In order to properly manage pests on your farm, you will need to understand where they occur, their life stages, and their population sizes. Monitoring is a useful tool for gaining information about pests. Use the guidelines and information that follows to develop a monitoring program for pests on your crops.

Review *The Safe and Effective Use of Pesticides* for general information on how to identify pests. The University of California publishes UC IPM Pest Management Guidelines for many of the major crops grown in California. IPM Manuals are also available for several important crops grown in California. Information on how to obtain these and other useful publications is found on page 97 of the Appendix.

UC Cooperative Extension Service farm advisors in your county can also provide helpful information about monitoring pests on your crops.

Review Chapter 1 in *The Safe and Effective Use of Pesticides* for general information on how to identify pests. For specific information, see the references for the UC IPM Pest Management Guidelines and IPM Manuals at the bottom of this page.

PESTS

List all the important existing or anticipated pests of this crop here.

INSECT PESTS:

MITE PESTS:

WEEDS:

PLANT DISEASES:

NEMATODES:

VERTEBRATES:

OTHER PESTS:



PEST MANAGEMENT GUIDELINES

The University of California publishes *Pest Management Guidelines* for many of the major crops grown in California. These *Guidelines* provide a great deal of information about pests, how to monitor for them, and when to treat for them. The *Guidelines* also provide management options. *Guidelines* can be obtained from the local farm advisor's office (UC Cooperative Extension Service) in your county. The *Guidelines* are also available on the World Wide Web at:

<http://www.ipm.ucdavis.edu>

IPM MANUALS

IPM Manuals are also available for several important crops grown in California. These manuals contain excellent color photographs of crop pests and provide information on how to manage these pests. The manuals are available from your local farm advisor's office or from UC ANR Publications in Oakland. See the appendix for ordering information or go to <http://anrcatalog.ucdavis.edu>.

Soil maps are available from the U.S. Department of Agriculture Farm Service Agency.

SOIL AND WATER

To better understand how to protect the environment while you are using pesticides, learn about the soil types on your farm. Also, become aware of the special hazards, such as creeks, sloughs, or other waterways, where pesticides can cause contamination. Completing the following section will help you recognize conditions on your farm that must be considered before selecting and applying pesticides.

SOIL TYPE

What is the soil type for this location?

- Sandy
- Loam
- Clay
- Other:

GROUNDWATER CONTAMINATION

Does soil on your farm have potential for groundwater contamination?

- Yes
- No

If yes, Describe:

Is this property within or near a Groundwater Protection Area?

- Yes
- No

Areas of land in California that have been determined to be vulnerable to the movement of pesticides into groundwater are identified as Ground Water Protection Areas. This designation is based on factors such as soil type, climate, depth to the ground water. There are two types of Ground Water Protection Areas: leaching and runoff. Certain pesticides cannot be used in these areas unless the grower follows specific management practices.

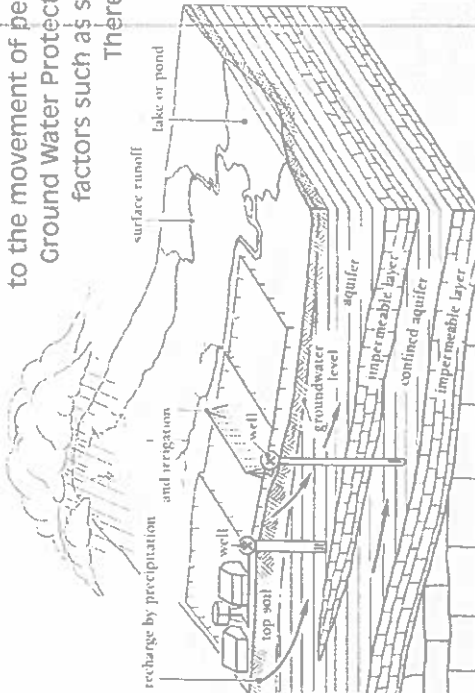

Water is present in underground reservoirs called aquifers. Aquifers under your farmland must be protected from pesticide contamination.

See pages 70-72 in this booklet and refer to the Groundwater Contamination section in *The Safe and Effective Use of Pesticides*. Go to the DPR website for the latest requirements.

PROFILE

On the last page of this *Profile*, draw a map of your farming operation and show the locations of the sensitive areas you listed here.

See pages 44-47 of this booklet and review the "Working With the Weather" section of *The Safe and Effective Use of Pesticides* for information on how weather influences pesticide applications.

SITE CONSIDERATIONS

Identify all the important structures, features (including schools, residences, farmworker housing, etc.), and environmental conditions on or surrounding your farm that need to be considered when making a pesticide application.

List here all dwellings, schools, buildings, commercial areas, parks, playgrounds, roads, and waterways that are within 1/2 mile of any area where you will apply pesticides:

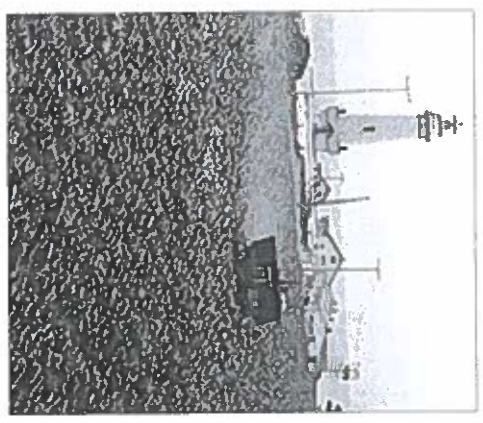

List all crops planted within 1/2 mile of this location and also list sensitive crops, such as grapes and rice, that are being grown in the area that may be affected by certain pesticide applications:

List any neighbors who will have field workers nearby:

WEATHER CONDITIONS

Are there unique weather conditions at this location that could influence pesticide applications?

- High rainfall
- Frequent windy conditions (describe):
- High humidity
- Dew
- Other:
- Fog

SECONDARY PESTS

Is there a possibility of a secondary pest outbreak as a result of controlling a target pest?

- Yes
- No

List any potential secondary pests here:

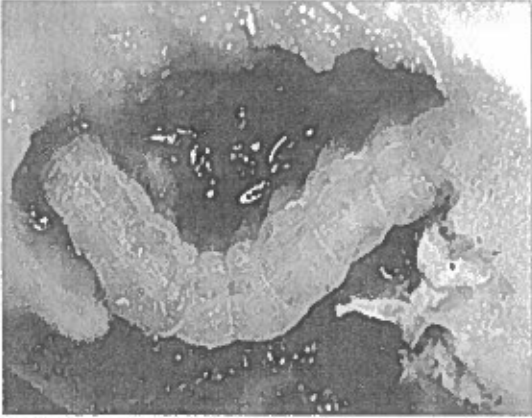

If natural enemies are destroyed by pesticides applied to control one pest, you may experience an outbreak of another secondary pest.

Sometimes a pesticide application will cause an outbreak of another pest, such as mites, because the pesticide has destroyed natural enemies or has lowered competition for the target crop. Refer to specific UC IPM Pest Management Guidelines and the IPM Manuals for information on secondary pest outbreaks.

BENEFICIALS

Are there beneficial insects, including honey bees, and other organisms that must be considered before making a pesticide application?

- Yes
- No

List here any beneficial organisms that might be affected by pesticide applications:

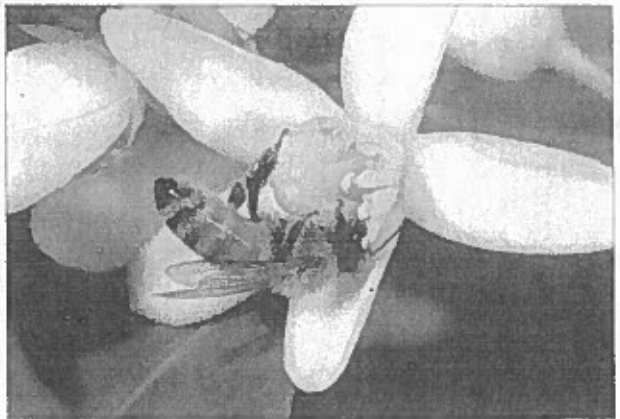

Refer to the UC IPM Pest Management Guidelines and the IPM Manuals for information on protecting beneficial organisms.

PROFILE

See Chapter 3 in this booklet and appropriate sections in *The Safe and Effective Use of Pesticides* for requirements for pesticide storage and disposal of pesticide wastes. Also, refer to the labels of pesticides you use for additional information.

See pages 64-70 and the appendix page 98 of this booklet for information and requirements on training workers. Obtain and post the Pesticide Safety Information Series A-8 *Safety Rules for Pesticide Handlers on Farms*. Also, see *The Illustrated Guide to Pesticide Safety* for training information for pesticide handlers and fieldworkers.

PESTICIDE STORAGE AND DISPOSAL

What provisions have you made for safe storage of pesticides and empty containers and for disposing of pesticide wastes? Describe your pesticide storage and disposal procedures here.

Storage:

Disposal of waste materials:

Disposal of empty rinsed containers and empty bags:



WORKER TRAINING AND PROTECTION

Worker training is an important part of planning for any pesticide application.

California regulations require that employees be adequately trained before handling pesticides and that they be given refresher training each year thereafter. See the Appendix for a list of topics that must be included in pesticide handler training. The employer must keep training records for at least two years.

Handling is defined as mixing, loading, or applying pesticides (including flagging) and maintaining, servicing, repairing, or cleaning contaminated equipment used in the mixing, loading, and application of pesticides.

State and federal laws require training of handlers. See the appendix for a sample training checklist. Get a copy of the Pesticide Safety Information Series A-8, *Safety Rules for Pesticide Handlers on Farms*.

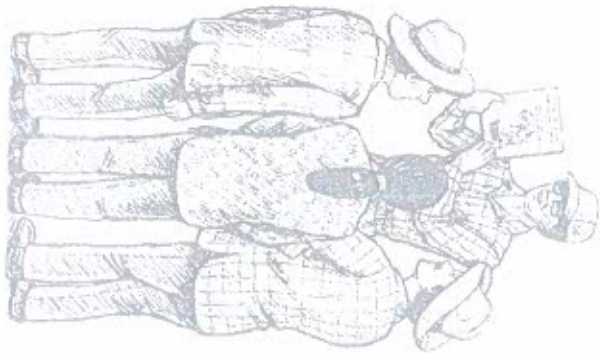

PESTICIDE HANDLERS

Do you have any employees, including family members, who handle any pesticide (this includes applying baits for rodent control)?

Yes No

Do you have a written training program for pesticide handlers? List the names of pesticide handlers here:

- 1.
- 2.
- 3.
- 4.
- 5.
- 6.

See appendix page 97 for information on handler training resources.

AGRICULTURAL FIELDWORKERS

Will there be anyone working in pesticide-treated areas within 30 days after the restricted-entry interval expires?

Yes No

Do you have any early-entry workers who will enter fields during the restricted-entry interval?

Agricultural fieldworkers and nursery workers must receive training on avoiding pesticide hazards if they work in fields or other areas treated with pesticides. Training is required for workers who enter treated areas any time during the 30-day period after the restricted-entry interval expires. Also, employers must comply with California's Pesticide Hazard Communication Program.

See appendix for training requirements and resources. Obtain a copy of the Pesticide Safety Information Series A-9, *Pesticide Safety Rules for Farmworkers*. This leaflet is available from your local county agricultural commissioner's office.

Workers who enter fields treated with any pesticide within 30 days after the end of the restricted-entry interval must receive special pesticide safety training.

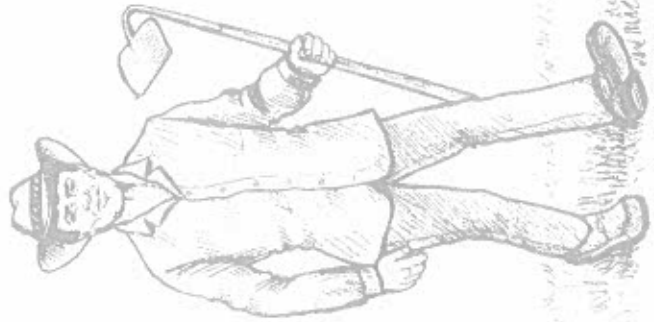

EMERGENCY MEDICAL CARE PREPARATIONS

Do you have an emergency medical care program for you, your employees, and your family members who handle pesticides?

- Yes No

Do you have employees using organophosphate or carbamate pesticides with the signal words Danger or Warning for more than 6 days in any 30-day period? If so, you must provide for medical supervision (cholinesterase testing).

- Yes No

Do all your employees know where this emergency medical care information is posted?

- Yes No

List names, locations, and telephone numbers of emergency medical facilities here. Also list the name and telephone number of the physician or clinic providing medical supervision for your employees.

Emergency Medical Facility

Name of facility:

Location:

Telephone number:

Medical Supervision for Employees

Name of physician or facility:

Location:

Telephone number:



See appendix page 103 for examples of organophosphate and N-methyl carbamate pesticides.

Post emergency telephone numbers and the address of the emergency care facility in a prominent location at the work site or on the work vehicle.

Keep the telephone numbers of emergency response agencies near your telephone and in your cell phone.

PREPARING FOR PESTICIDE EMERGENCIES

To reduce chances of injury or environmental contamination when using pesticides, develop an emergency plan. Obtain first aid supplies, a spill cleanup kit, and information about the pesticides you are using. Take training on first aid procedures and CPR.

First aid supplies for pesticide exposure should include a supply of clean water, soap, and single use towels for whole body washing, clean water for emergency flushing of the eyes, clean coveralls or other changes of clothing, and decontamination instructions.

FIRST AID

Do you and your employees know the practical first aid procedures, as listed on the pesticide labels, for pesticide exposure incidents?

- Yes No

Describe here the location where first aid supplies for pesticide exposure are kept on your farm or other operation:



Refer to the pesticide labels and Material Safety Data Sheets for specific first aid information relating to the pesticides used on your farm.

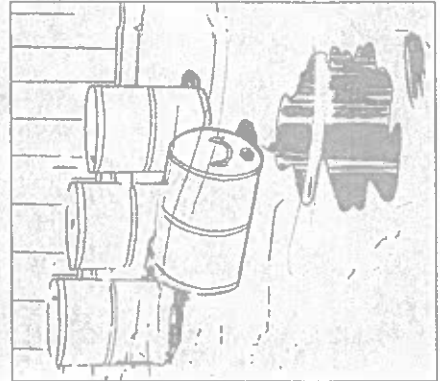

PESTICIDE SPILLS

Have you assembled spill cleanup materials and do you have a plan for handling pesticide spills?

- Yes No

List here the types and location of pesticide spill cleanup materials:

Material Safety Data Sheets are useful resources for spill cleanup procedures.

For information on dealing with pesticide spills, see pages 82-84 in this booklet.

PROFILE

See the Material Safety Data Sheets for each pesticide stored or used on your farm. The MSDS provides useful information for fighting fires.

PESTICIDE-RELATED FIRES

Do you know what to do in case of a fire involving pesticides?

Yes NO

Have you provided local authorities with a list of pesticides stored at your farm?

Yes NO

Provide an inventory of your storage of pesticides, fuels, and fertilizers for your local fire department. This will help them prepare for fighting a fire, should it occur. Other agencies may require this information as well. Check with your agricultural commissioner's office for reporting requirements. Read the information on dealing with pesticide fires on pages 84-85 of this booklet.

YOUR PEST MANAGEMENT PROGRAM

To manage pests on your farm most effectively, use several methods of control. Often a combination of different types of control methods is more effective than one single control.

Naturally occurring beneficial organisms can contribute to the control of pests on your farm. You must know the status of the pest populations and what beneficials are present when planning your pest management program. This requires careful monitoring.

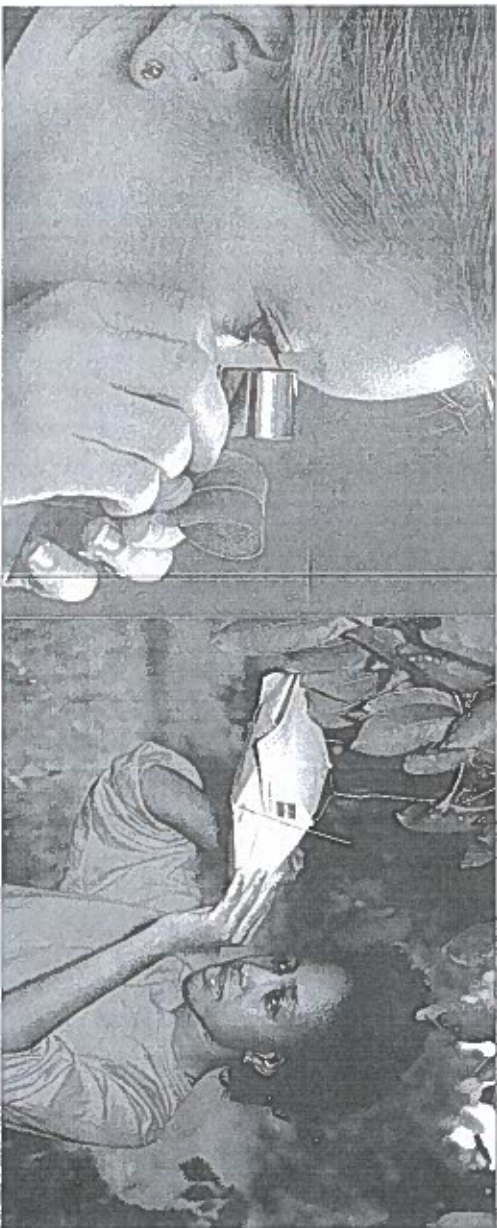

BENEFICIAL INSECTS AND MITES

Are there naturally occurring beneficial species present in this crop that can help control the pests with which you are concerned?

- Yes
- No

List the beneficials and pests they might help to control:

Beneficial

Pest



Are there beneficial species you can purchase to augment the natural control of some pests of this crop?

- Yes
- No

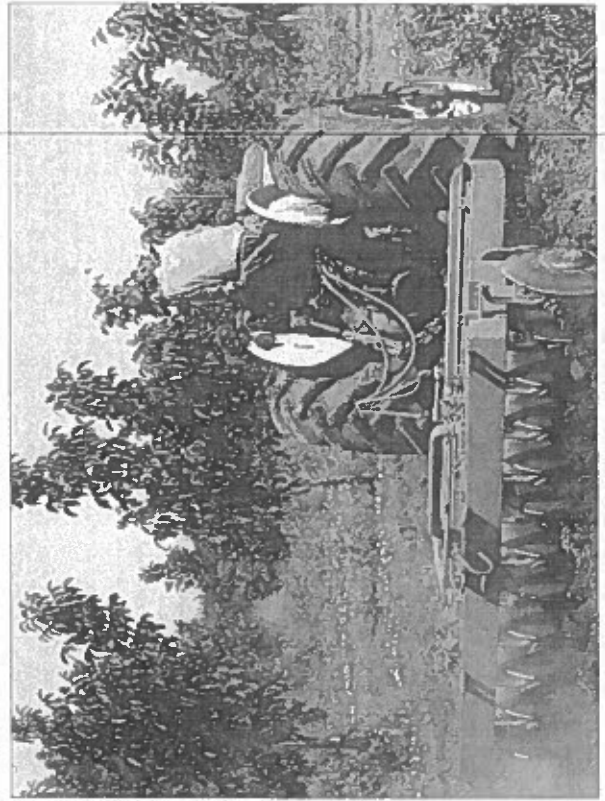

CULTURAL PRACTICES

Are there cultural practices you can perform that will help to control pests in this crop or assist in preventing pest infestations?

- Yes
- No

Describe cultural practices here:

The *UC IPM Pest Management Guidelines and IPM Manuals*, as well as the *Natural Enemies Handbook: The Illustrated Guide to Biological Pest Control*, will help you identify beneficial species and provide information on how they control pests.

Check with your local UC Cooperative Extension farm advisor for information on purchasing and using natural enemies to control certain pests.

The *UC IPM Pest Management Guidelines* describe cultural practices that can help manage pests on your crops.

See appendix page 90
for a Checklist for
Planning a Pesticide
Application.

Obtain copies of
labels from your pest
control dealer for all
the pesticides you
are considering.
Compare the use and
hazard information
and become familiar
with use restrictions.

SELECTING AND PURCHASING THE RIGHT PESTICIDE

Pesticides include insecticides, herbicides, fungicides, nematocides, rodenticides, attractants, repellents, defoliants, and plant growth regulators. Other types of pesticides include piscicides (for controlling fish), avicides (birds), molluscicides (slugs and snails), and silvicides (trees and woody shrubs).

Usually, you will have several choices for each pest you may need to control. Each pesticide has some distinct characteristic that may influence your selection. Apply the guidelines listed below to each pesticide you are considering. In this way you will buy pesticides that best meet your needs and the conditions of your crop and farm.

All agricultural-use pesticides used in California must be purchased from Department of Pesticide Regulation-licensed *Pest Control Dealers*. Beware of pesticides promoted through the Internet, telephone solicitations, or out-of-state catalogs. You may be unknowingly purchasing materials that are not registered for use in the state, which could subject you to enforcement actions. Unlicensed dealers are breaking the law if they sell you any agricultural-use pesticides.

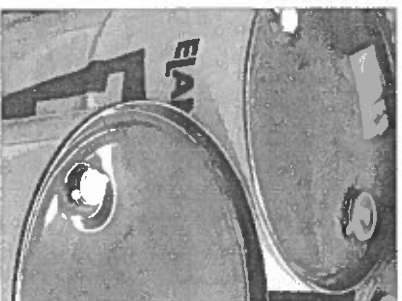

CHECK OUT PESTICIDE LABELS

Have you read labels of all the pesticides you are considering?

- Yes No

List specific hazards of the pesticides you are planning to use (hazards include danger to the environment, toxicity to fish, injury to treated plants, etc.):

ARE THE PESTICIDES REGISTERED FOR THIS CROP?

Only use pesticides that are registered for this crop! Your crop must be listed on the pesticide label, otherwise it is an illegal application. If you are in doubt, contact your agricultural commissioner.

List the pesticides you are considering and confirm that they are registered for use on this crop:

SPECIFIC PESTICIDE HAZARDS

Are there any specific hazards that will require special handling or care?

- Yes No
- Hazards to handlers
 - Fieldworker exposure potential
 - Hazards from drift
 - Potential for groundwater contamination
 - Precautions against grazing livestock on crop residues
 - Other precautions (including tank mix restrictions):

PREHARVEST INTERVAL

Preharvest intervals are found with the crop information on the pesticide label. A preharvest interval is the time that must pass after the pesticide application before the crop can be harvested. However, workers may perform cultural practices before harvest as long as the restricted-entry interval has passed. Is there a preharvest interval listed on the label that will conflict with your harvest needs?

- Yes No

Check the precautionary statements part of the pesticide label for restrictions or precautions. Some pesticides may be incompatible when mixed with other pesticides (tank mixes).

RESTRICTED-ENTRY INTERVALS

A restricted-entry interval is the time that must pass after a pesticide is applied before anyone can enter the treated area.

All pesticides have restricted-entry intervals. Pesticide labels list restricted-entry intervals. Remember, however, California may have longer intervals than those listed on the label.

Check with the agricultural commissioner's office or the Pest Control Adviser making the recommendation.

Do you know what the restricted-entry intervals are for each pesticide you will be using?

- Yes No



PLANTBACK RESTRICTIONS

Plantback restrictions are listed on the pesticide label, and these restrictions limit planting certain crops to treated fields for a specified period. Plantback restrictions are sometimes needed because pesticide residues left behind in the soil can harm future crops or result in illegal pesticide residues on those crops.

If there are plantback restrictions, are these compatible with your cropping system?

- Yes No

List specific crops that cannot follow the application of any of the pesticides you are considering and the length of the plantback interval:

PHYTOTOXICITY

Check the pesticide label carefully. Some pesticides may injure certain species or varieties of plants or may cause injury during specific environmental conditions such as above a certain temperature or when plants are water stressed.

Are there phytotoxicity warnings of which you must be aware?

- Yes No

List specific conditions you must meet to avoid phytotoxicity problems:

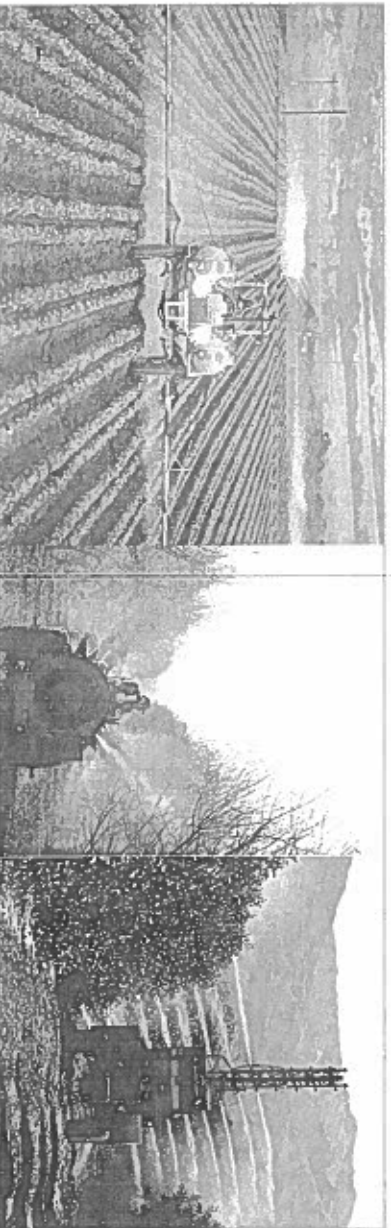

ENVIRONMENTAL HAZARDS

Are there label warnings of potential environmental contamination?

- Yes No

List special precautions you must observe to prevent environmental contamination to:

Groundwater:

Endangered Species:

Other:

Check the *precautionary statements* section of the pesticide label carefully for environmental concerns.

APPLICATION RESTRICTIONS

Are there restrictions on the frequency or number of applications that can be made in a season?

- Yes No

List application frequency restrictions here:

Are there restrictions to applying the pesticides to certain crop development stages?

- Yes No

List crop stage restrictions here:

Some pesticides have restrictions on the number of applications or the frequency of application in a season. There may be restrictions limiting the total pounds of active ingredient that can be applied in a season. There may be restrictions against application during certain crop development stages. This information will be found in the *directions for use* section of the pesticide label.

Read the entire pesticide label to find out if there are restrictions on when the pesticide may be applied and how often it can be used.

ENDANGERED SPECIES

Are there restrictions to using any of these pesticides because of the presence of endangered species?

- Yes
- No

List any endangered species of concern at your farming location:

The label will specify endangered species of concern. Check with the local agricultural commissioner's office for a listing and location of endangered species that might affect your use of certain pesticides.

FARM MAP

Place a drawing or map of your farming operation here. Show the locations of adjacent crops, houses, roads, waterways, and any other sensitive areas.

Place a drawing or map of your farming operation here. Show the locations of adjacent crops, houses, roads, waterways, and any other sensitive areas.

Chapter 1 THE PESTICIDE LABEL

Pesticide labels are your most important source of information when you use pesticides. The information on pesticide labels is put there for your protection. If you read, understand, and follow this information, your likelihood of injury or accident is reduced (Figure 1-1). Pesticide labels are legal documents and you are required to follow the directions on these labels. Any violation of the label instructions is a violation of the law. *The most important few minutes in chemical pest control is the time you spend reading these labels.*

Regulations establish the format for pesticide labels and prescribe what information they must contain. Some packages are too small, however, to have all this information printed on them, so manufacturers are required to attach *supplemental labels*. Labels may also refer you to other documents, such as endangered species range maps, that must be consid-

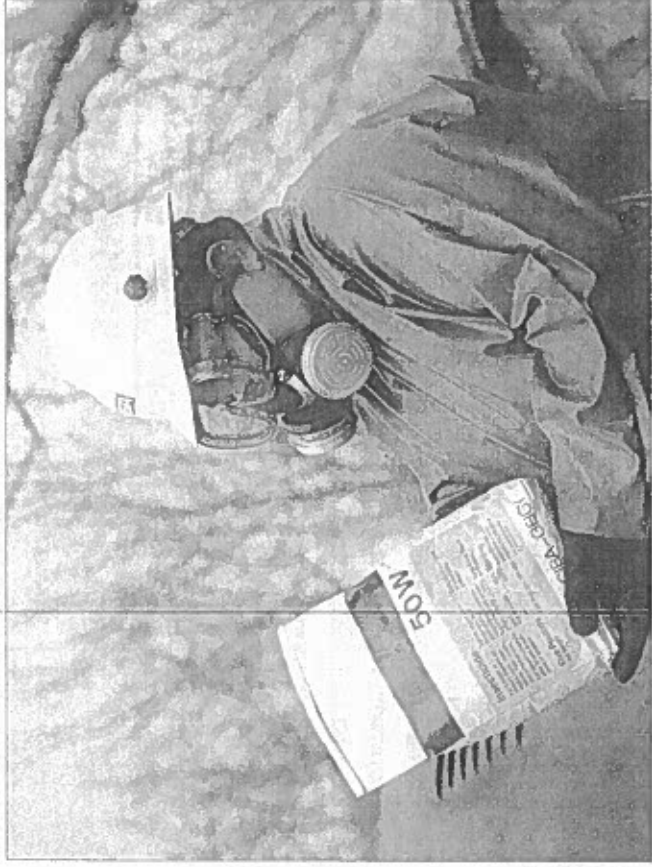

Figure 1-1. Reading the pesticide label is one of your most important steps in making a pesticide application. Remember, the pesticide label is the law.

ered part of the *labeling*. Pesticide labels provide information to help you legally and economically use those products. Obtain, read, and understand all the information on a label, supplemental labeling, and referenced documents before making a pesticide application. If you

have doubts about how, when, or where to use a pesticide, check with your local county Agricultural Commissioner. You can incur serious legal penalties for violating label instructions. In addition, crop damage, personal injury, environmental

Obtain all pesticide labeling from your chemical supply dealer.

pollution, or waste of time and pesticides are some other costly consequences resulting from your not following the instructions on pesticide labels.

LEARN TO USE PESTICIDE LABELS

The review questions at the end of this chapter deal with how you find information on pesti-

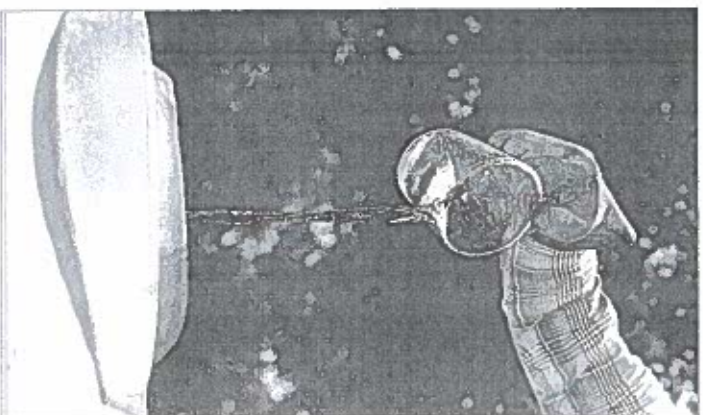

Figure 1-2. Before opening the pesticide container, learn the precautions you must take to prevent injury.

cide labels. After reading the following information, rest your knowledge by answering these review questions. The following sections describe when to read the label and what the label sections mean.

When to Read the Pesticide Label

Read the pesticide label:

1. *Before purchasing the pesticide.* Make sure the pesticide is registered for your intended use. Confirm that there are no endangered species restrictions or other conditions that prohibit the use of this pesticide at the application site. Be certain it can be used under current weather conditions and against the pest life stage you are trying to control. Find out what protective equipment and special application equipment you need. Do not buy the pesticide on the basis of reading only the brand name. Keep in mind that manufacturers change products, formulations, and methods of application without changing brand names.

2. *Before mixing and applying the pesticide.* The complete label

(including the label and supplemental labeling) must be at your pesticide mixing site. Read the label to understand how to mix and safely apply the material (Figure 1-2). Learn what precautions are needed to prevent exposure to people and nontarget organisms. Find out what first aid and medical treatment is necessary should an accident occur.

3. *When storing pesticides.* Find out how to properly store the pesticide to prevent breakdown or contamination. Understand the special precautions to prevent fire hazards. Be sure storage areas are properly posted. Refer to the *Pesticide Safety Information Series A-2* for information on storage, transportation, and disposal of pesticides and containers.

4. *Before disposing of unused pesticide and empty containers.* Learn how to prevent environmental contamination and hazards to people. Before disposal, check with the county Agricultural Commissioner in your area for local restrictions and requirements. See the *Pesticide Safety Information Series A-2* for further information on disposing of containers and unused material.

Parts of the Pesticide Label

Each pesticide label is required to follow a specific format and usually must include each of the following sections. Use the sample pesticide label on the next page to locate these sections. Sections on the sample label are numbered 1 through 10 to correspond to the sections listed below.

1 Brand Name, Chemical Name, and Common Name. A *brand name* is the name the manufacturer has given to the product and is the name used for all advertising and promoting. It is usually the largest and most conspicuous wording on the label.

The *chemical name* describes the chemical structure of a pesticide and is derived by chemists based on international rules for naming chemicals.

Most pesticide chemicals have an official *common name* assigned to the active ingredient; this is a generic name and it may be found on the label of many brands if each contains the same active ingredient. Common names and brand names are not

the same and not all labels will list a common name for the pesticide.

2 Formulation. The formulation is the way the active ingredient is mixed with inert ingredients to make it ready for you to use. Some examples of formulations are *wettable powders* and *emulsifiable concentrates*.

3 Ingredients. All of the active ingredients in a pesticide formulation must be listed on the label. These are given as percentages by weight. The inert (non-pesticide) ingredients are not listed by chemical name but the label shows what percentage of the total material in the formulation is inert ingredients.

4 Contents. The label will tell you how much material is in the container. For example, one container might contain 5 gallons of liquid while another will hold 25 pounds of powder.

5 Manufacturer. Each pesticide label must include the name and address of the company manufacturing and distributing the pesticide. The registrant may differ from the manufacturer.

6 Registration and Establishment Numbers. Each pesticide product has a unique federal registration number. The U.S. EPA (and sometimes the California Department of Pesticide Regulation) assigns registration numbers to pesticide products as they are registered. In addition, the U.S. EPA Establishment Number is a code on the pesticide label which identifies the site of manufacture or repackaging.

7 Statement of Use Classification. The U.S. EPA categorizes every pesticide as either unclassified or restricted-use. You can use restricted-use pesticides only if you are a certified applicator or work under the supervision of a certified applicator. A *restricted use statement* appears on labels of the EPA-restricted pesticides. Some pesticides are California-restricted but not EPA-restricted. You must have a permit from the agricultural commissioner before you buy or use any restricted pesticide. Obtain a copy of the current restricted materials list from the agricultural commissioner.

8 Signal Words and Symbols. An important part of every label is the SIGNAL WORD (Figure 1-3).

RESTRICTED USE PESTICIDE
 FOR RETAIL SALE TO AND APPLICATION ONLY BY CERTIFIED APPLICATORS **7**
 OR PERSONS UNDER THEIR DIRECT SUPERVISION

NOPEST[®] SOLUPAK

50% WETTABLE POWDER

CROP INSECTICIDE

IN WATER SOLUBLE PACKETS

1
2

FOR EFFECTIVE ECONOMICAL INSECT CONTROL

ACTIVE INGREDIENT: *O,O* Dimethyl *S*-[(4-oxo-1,2,3-benzotriazin-3(4*H*)-yl)methyl]phosphorodithioate 50%
 INERT INGREDIENTS: 50% **3**

Keep water soluble packets in this container and store in a cool dry place, but not below freezing (32°F). Protect from heat. Keep away from open flame. Do not heat. Entire inner packets dissolve in water. After opening outer bag, drop the required unopened inner packets into spray tank as directed. Do not excessively handle water soluble packet or expose it to moisture, since this may cause breakage.

DEALERS SHOULD SELL IN ORIGINAL PACKETS ONLY
 CONTAINS 5 ONE-POUND WATER SOLUBLE PACKETS **6**

EPA Reg. No. 3333-301

TOTAL NET CONTENTS: 5 POUNDS **4**

STOP - READ THE LABEL BEFORE USE
 KEEP OUT OF REACH OF CHILDREN

DANGER



POISON

8

PELIGRO

Si usted no entiende la etiqueta, busque a alguien para que se la explique a usted en detalle.
 If you do not understand the label find someone to explain it to you in detail.

PRECAUTIONARY STATEMENTS
HAZARDS TO HUMANS AND DOMESTIC ANIMALS **9**

Fatal if swallowed, inhaled, or absorbed through the skin. Do not get in eyes or on skin. Do not breathe spray mist. Spray operator should work to windward to stay out of drift or mist. When handling the concentrate, wear a protective suit of one or two pieces that covers all parts of the body except the head, hands, and feet. Wear chemical resistant gloves, chemical resistant apron, and chemical resistant shoes, shoe coverings, or boots. Wear goggles or a face shield and a pesticide respirator approved by the National Institute for Occupational Safety and Health under the provision of 30 CFR Part 11. During application, equipment repair, equipment cleaning, reentry, and disposal of the pesticide wear a protective suit of one or two pieces that covers all parts of the body except the head, hands, and feet. Wear chemical resistant gloves and chemical resistant shoes, shoe coverings, or boots. Wear a chemical resistant hat during airblast application.

ENVIRONMENTAL HAZARDS

This product is extremely toxic to fish and wildlife. Do not apply directly to water or wetlands (swamps, bogs, marshes, and potholes). Do not contaminate water by cleaning of equipment or disposal of wastes. Drift and runoff from treated areas may be hazardous to aquatic organisms in neighboring areas.

FOR ADDITIONAL HAZARDS SEE INSIDE LABELING

DIRECTIONS FOR USE: Use specified dosage of NOPEST SOLUPAK in the amount of water necessary to give complete coverage of foliage. Determine the total amount of wettable powder to be added to the spray tank based on the rates **10**
 (Continued on next page)

ABC CHEMICAL COMPANY, 1234 MAIN STREET, ANYTOWN, USA 00001 - 1-800-123-4567 **5**

The word *Danger*, accompanied by the word *Poison* and a skull and crossbones, or the word *Danger* used alone tells you that the pesticide has high acute toxicity or poses a dangerous health or environmental hazard. *Warning* indicates moderate acute toxicity and *Caution* means low acute toxicity. Part of the registration process prescribes which SIGNAL WORD must be used on the label.

9 Precautionary Statements. PRECAUTIONARY STATEMENTS are used to describe the human and environmental hazards associated with a pesticide. See Chapter 3 of this booklet for information on avoiding environmental and human hazards, and Chapter 4 for information on protecting people from pesticide exposure when accidents occur.

The PRECAUTIONARY STATEMENTS section is an extremely important section on a pesticide label because it tells you how to avoid exposure and provides information on the personal protective equipment (PPE) that you are required to wear. This section includes first aid instructions and often will have information for physicians. Always read and follow

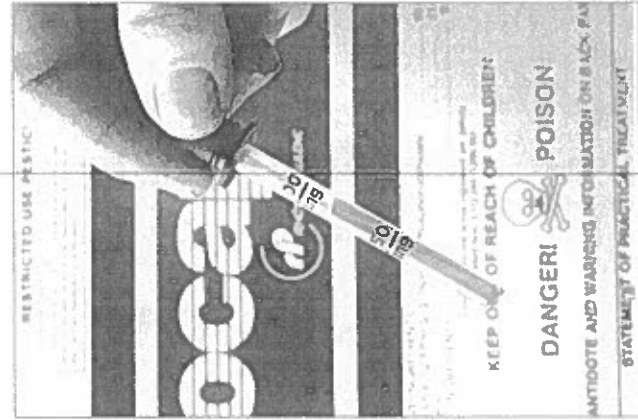

Figure 1-3. The signal word indicates the toxicity or other hazards of a pesticide. Pesticides with the signal word DANGER accompanied by a skull and crossbones symbol are the most hazardous.

the instructions and protective measures given in a PRECAUTIONARY STATEMENT.

The PRECAUTIONARY STATEMENTS may indicate which routes of entry (mouth, skin, eyes, lungs) you must particularly protect (Figure 1-4) and what specific actions you need to take to avoid acute injury from pesticide exposure. Many pesticides can cause acute effects by more than one route, so study these statements carefully. They will tell you what parts of

your body will need the most protection.

Information on delayed health effects and potential allergic effects (sensitization) of pesticides is also included in the PRECAUTIONARY STATEMENTS section of pesticide labels.

10 Directions for Use. The DIRECTIONS FOR USE include information on the *Agricultural Use Requirements* if you use the pesticide on an agricultural plant commodity for production or research purposes on farms, or in greenhouses, nurseries, or forests. It includes the restricted-entry interval and personal protective equipment requirements for *early entry workers*. This section refers you to the provisions of the Federal Worker Protection Standard for additional requirements. These Worker Protection Standard requirements are now addressed by California's pesticide regulations. Be aware that California may have more strict worker safety requirements than the U.S. EPA so it is important that you are familiar with California pesticide regulations. If you have questions about how to follow the label, consult with the agricultural com-

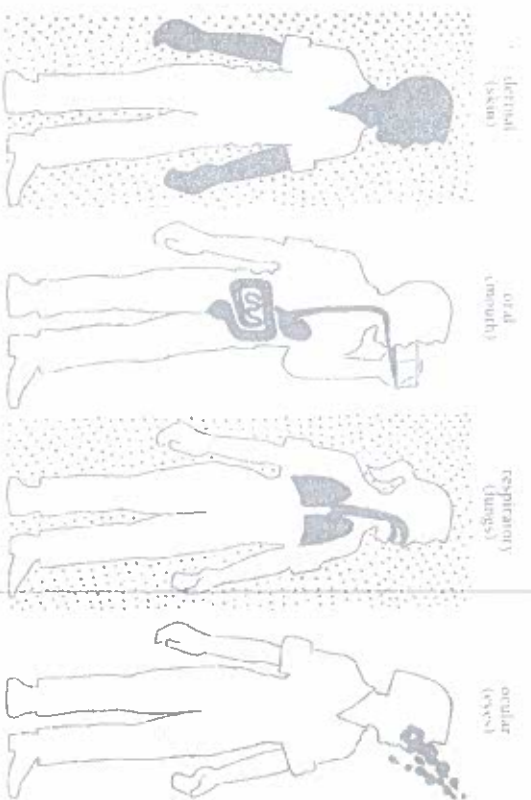

Figure 1-4. Pesticides can enter your body through these four routes of exposure. Read the pesticide label to understand the hazards.

missioner. Also included in the DIRECTIONS FOR USE is information you need on storage and disposal of the pesticide.

Refer also to the Pesticide Safety Information Series A-2—*Storage, Transportation, and Disposal*, for California-specific storage, transportation, and disposal requirements.

The DIRECTIONS FOR USE list target pests that the pesticide has been registered to control, plus the crops, plant species, animals, or other sites where the pesticide may be used. The directions may also

include special restrictions that you must observe, such as crops that may not be planted in the treatment area (plantback restrictions) and restrictions on feeding crop residues to livestock or grazing livestock on treated fields.

The DIRECTIONS FOR USE tell you how to apply the pesticide, how much to use, where to use the material, when it should be applied, and also include preharvest intervals for all crops whenever appropriate. A preharvest interval is the time, in days, required after application before your agricultural crop may be harvested.

Always follow these DIRECTIONS FOR USE. Remember: It is a violation to use pesticides in a manner inconsistent with the label unless federal or state laws specify acceptable deviations from label instructions.

WORKER PROTECTION INFORMATION

A revision to the Federal Insecticide, Fungicide, and Rodenticide Act (FIFRA), known as the *Federal Worker Protection Standard*, has made some significant changes and improvements to pesticide label requirements. These revisions also led to changes in California's regulations so the state's regulatory program would meet federal guidelines.

The PRECAUTIONARY STATEMENT section contains specific personal protective equipment (PPE) requirements when you handle pesticides.

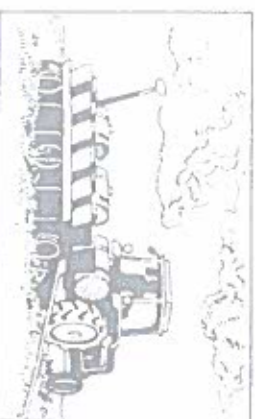

The DIRECTIONS FOR USE section of pesticide labels addresses restricted-entry intervals and post-entry or oral notification requirements for fieldworkers. It prescribes the personal protective equipment needed for early entry workers. This section may reference the Worker Protection Standard training requirements for handlers and fieldworkers and the need to maintain records and information about pesticide applications. However, California regulations may require additional worker safety precautions.

Personal Protective Equipment (PPE). The PRECAUTIONARY STATEMENT sections of pesticide labels contain personal protective equipment requirements you must follow when handling the pesticide. Remember: you are a *pesticide handler* if you (1) mix, load, or apply pesticides; (2) clean or repair contaminated application equipment; (3) transport, store, or handle pesticide containers after the manufacturer's seal is broken; (4) work as a flagger; or (5) dispose of pesticides or un rinsed containers. Anyone who works for you and performs any of these functions is also a pesticide handler.

Restricted-Entry Intervals. When any pesticide is applied on your property, you or your employees cannot enter the treated area unless a specified period of time has elapsed. This time is known as the *restricted-entry interval* (Figure 1-5). For the first four hours after any pesticide is applied, no one may enter the area except for severe emergencies. Some exceptions are allowed for persons entering the treated area after four hours but before the specified

restricted-entry interval lapses. These people must be trained as *early-entry workers* (see below).

Many pesticide labels list the specific restricted-entry intervals. In California, longer intervals may apply to certain pesticides, and these intervals may not be listed on pesticide labels. See page 102 in the Appendix for a recent listing of California restricted-entry intervals. Always check with the agricultural commissioner to determine the correct interval.

The U.S. EPA Federal Worker Protection Standard establishes a minimum restricted-entry interval of 12 hours for most signal word *Caution* pesticides; most signal word *Warning* pesticides have minimum restricted-entry intervals of 24 hours; pesticides with the signal word *Danger* have minimum restricted-entry intervals of 48 hours, and all signal word *Danger* organophosphate insecticides used in "dry areas" (under 25 inches of average rainfall each year) have minimum restricted-entry intervals of 72 hours. Most of California's agricultural areas receive an average of less than 25 inches of rainfall each year. Check with your agricultural commissioner for



Figure 1-5. All pesticides have a restricted-entry interval listed on the label. During this period of time after a pesticide application, you or your employees cannot enter treated areas without wearing appropriate personal protective equipment.

The appendix on page 102 lists restricted-entry intervals for some pesticides and crops grown in California. These may be longer than the intervals listed on pesticide labels.

more information on restricted-entry intervals.

Notification. You must notify employees working on your farm of any pesticide applications and restricted-entry intervals in effect if they will be working within 1/4 mile of the treated areas. You need to tell them the treatment location, timing, pesticide name, and any precautions they should take. Pesticide labels may specify the method of notification you must use—posting or oral notification—or both. If no method is specified, you may notify workers either orally or by posting. California regulations *require* field posting if the restricted-entry interval exceeds 7 days. See the Pesticide Safety Information Series A-9 for posting requirements and be sure to post it where workers will see it. If you have workers who handle pesticides, you must train them



and post Pesticide Safety Information Series A-8. Both A-8 and A-9 are available in various languages. Your employees must have access to pesticide use records for treated fields and for materials they handle. You also must supply a Material Safety Data Sheet (MSDS) (see pages 32-33 for sample) if requested. See the appendix for pesticide handler training information and form.

Early-Entry Workers. People who must perform certain allowed cultural activities that involve limited contact with treated surfaces in treated areas before restricted-entry intervals expire are known as *early-entry workers*. You must provide early-entry workers with special training and PPE specified on the label for early entry. You must also assure that they will have no contact with anything that has been treated, including soil, water, and plant surfaces. Only limited contact activities that are necessary and unforeseen, such as irrigation, are allowed and, depending on the activity that is performed, there are limitations on how long early entry employees may be in the field. If the restricted entry interval is for a pesticide that requires both oral

warning and field posting, early entry is not allowed. Early entry cannot be sooner than 4 hours after the application. See the appendix for early-entry training information for your workers.

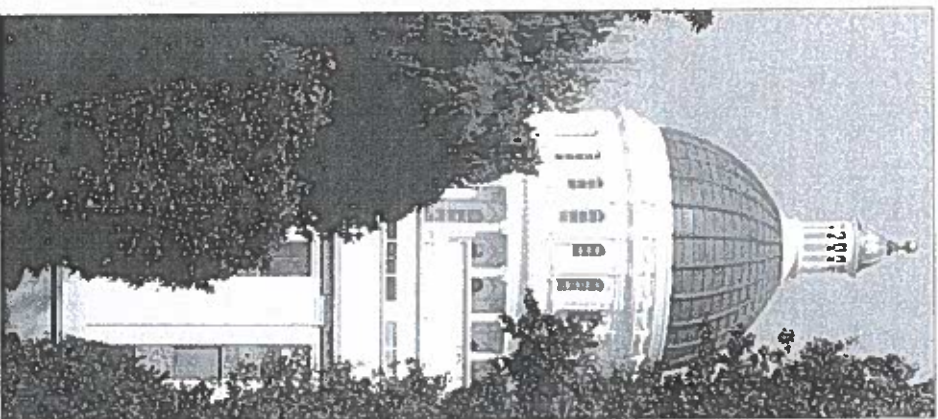
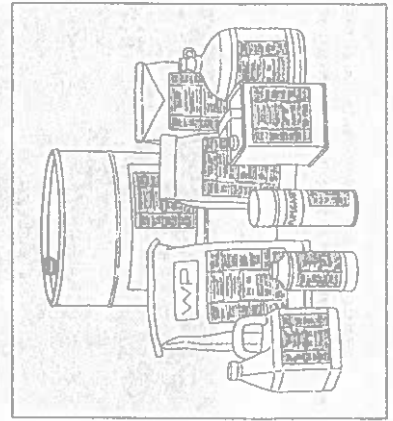

Figure 1-6. The Department of Pesticide Regulation, as well as the U.S. EPA, must register pesticides before they can be used in California.

PESTICIDE PRODUCT REGISTRATION

No pesticide may be sold in the United States until the U.S. EPA has reviewed the manufacturer's application for registration and determined that the use of the product will not present an unreasonable risk to humans or the environment (Figure 1-6). As part of this product registration process, U.S. EPA has certain labeling information requirements and must approve all language that the manufacturer proposes to include in the product labeling. U.S. EPA reviews the labeling to make sure that it contains all the information needed for safe and effective use of the pesticide product and that the information is backed up by data submitted (or cited) by the manufacturer.



The U.S. EPA may require the manufacturer to change the labeling if it does not contain enough information or if the information is wrong. The U.S. EPA also may require that the labeling include other information about laws or regulations that have been adopted to protect humans or the environment.

Only after U.S. EPA has reviewed the labeling and registered the product can a pesticide be sold. If the manufacturer wants to change the information in the labeling after the product and labeling are registered, the U.S. EPA must approve the change. The U.S. EPA also may require changes in labeling.

All pesticides used in California must also be registered with the California Department of Pesticide Regulation (DPR). Only DPR-licensed pest control dealers may sell pesticides intended for agricultural use or restricted use pesticides. California registered pesticides are listed on DPR's website at <http://www.cdpr.ca.gov/docs/label/labelque.htm#regprods>. If you use pesticides that have not been registered by DPR, you will be subject to enforcement action.

TYPES OF PESTICIDE PRODUCT REGISTRATION

You may apply only California registered pesticides or pesticides exempted from registration by the U.S. EPA and DPR to crops on your farm. You may encounter three types of registrations or registration exemptions:

Federal Registration (section 3). Federal registrations are the most common. Most pesticide uses are registered this way. Look for the U.S. EPA Registration Number, which must appear on the label, to be sure you are buying an approved product.

Special Local Need Registration (section 24c). Special Local Need registrations, known as SLN or 24(c) registrations, allow states to expand the ways certain pesticides can be used in their jurisdictions, including registering additional uses or adding limitations for a federally registered pesticide. These registrations often involve adding application sites, pests, or alternate application techniques to those listed on the federally registered labeling. Labeling must be provided for each SLN registration.

You must have a copy of the SLN labeling in your possession in order to apply the pesticide for that purpose. The registration number for Special Local Needs labeling will include the initials SLN and the standard two-letter abbreviation code for the state that issued the registration (CA). These registrations are legal only in the state or local area specified in the labeling. If you make an application of a pesticide having an SLN from another state or region you will be subject to civil and criminal penalties.

Staff from the agricultural commissioner's office, UC Cooperative Extension farm advisors, pest control dealers, or pest control advisers can help inform you of SLN registrations that pertain to your crops and area.

Emergency Exemption from Registration (section 18). When an emergency situation arises, DPR is allowed by the U.S. EPA to approve the use of an unregistered pesticide for a specified period of time. This process, called a Section 18 emergency exemption, follows strict federal guidelines. If the emergency exemption is for a food or feed crop, U.S. EPA establishes a time-limited tolerance. The application for a Sec-

tion 18 exemption must include an economic justification documenting significant crop losses and no registered, effective product or cultural practice available to control the pest. All section 18 uses are restricted materials so you will need a permit from the agricultural commissioner and must carefully follow all use guidelines on the section 18 label. Stricter controls and record keeping are required.

MATERIAL SAFETY DATA SHEETS

Material Safety Data Sheets (MSDSs) provide you with valuable information about pesticide hazards. These sheets are prepared by manufacturers and must be made available to every person selling, storing, or handling pesticides (Figure 1-7).

Be sure to obtain MSDSs for every pesticide used on your farm. These sheets are helpful because they describe the chemical characteristics of active and other hazardous ingredients and list fire and explosion hazards, health hazards, reactivity and incompatibility characteristics, and types of protective equipment needed for safe

handling of the concentrated material. Storage information and emergency spill or leak cleanup procedures are described.

LD₅₀ and LC₅₀ ratings (lethal doses and lethal concentrations, based on laboratory animal test data) are given for various test animals. MSDSs are also important sources of information on acute and long-term health effects that could result from overexposure to the pesticides.

Keep MSDSs in a safe place at a central location at the workplace, away from your pesticide storage area. However, be sure they are available for quick reference. Give



Figure 1-7. Refer to the Material Safety Data Sheet for each pesticide you use on your property. The MSDS provides information about the pesticide hazards and how to handle spills and fires.

the MSDSs to emergency personnel in case of accidental spills or fires involving pesticides on your farm. Material Safety Data Sheets, like the sample illustrated on pages 32–33, conform to a general format. Information covered on a MSDS includes:

Chemical Product and Company Identification. This section of the Material Safety Data Sheet lists company information, including emergency telephone numbers. Product name and other names used for this product are listed.

Composition Information on Ingredients. The chemical ingredients, percent of active ingredients, and percent of inert ingredients are listed in this section. Ingredients that are classified as hazardous chemicals under the criteria of the OSHA Hazard Communication Standard are identified.

Hazards Identification. This section provides emergency workers with information about the hazards associated with the pesticide, including common routes of exposure and health effects should exposure occur.

First Aid Measures. Similar information on first aid measures



Figure 1-8. The Material Safety Data Sheet provides you with valuable information on cleaning up pesticide spills.

is provided on the MSDS as is found on the product label. An emergency telephone number for additional information may be listed here.

Fire Fighting Measures. This section is useful to emergency personnel who will be required to fight a fire on your premises in which the pesticide is involved. Be sure to supply this information to fire personnel.

Accidental Release Measures. Detailed information is given here for cleaning up spills of the pesticide (Figure 1-8). Manufacturers usually provide recommendations of materials that work best for decontaminating areas where spills occurred.

Handling and Storage. This section provides you with guidance on hazards to avoid while handling and storing the pesticide.

Exposure Controls/Personal Protection. Important information about personal protective equipment (PPE) is contained in this section of the Material Safety Data Sheet. This information may be similar to the information found in the PRECAUTIONARY STATEMENTS section of the pesticide label but the label is the preferred source for PPE. Exposure guidelines, if any, will also be found here.

Physical and Chemical Properties. Specific information about the physical and chemical proper-

MONSANTO Company
ROUNDUP ORIGINAL™ Herbicide

Version: 1.2

Effective date: 01/25/2001

Page: 1

MONSANTO Company
Material Safety Data Sheet
Commercial Product

1. PRODUCT AND COMPANY IDENTIFICATION

Product name
ROUNDUP ORIGINAL™ Herbicide

EPA Reg. No.
52-445

Product use
Herbicide

Chemical name
Not applicable

Synonyms
None

None

Company
MONSANTO Company, 800 N. Lindbergh Blvd., St. Louis, MO, 63167

Telephone: 800-332-3111, Fax: 314-694-5557

Emergency numbers

FOR CHEMICAL EMERGENCY, SPILL LEAK, FIRE, EXPOSURE, OR ACCIDENT, CALL CHEMTREC - Day or Night: 1-800-424-9300 toll free in the continental U.S., Puerto Rico, Canada, or Virgin Islands. For calls originating elsewhere: 703-527-3887 (collect calls accepted).

FOR MEDICAL EMERGENCY - Day or Night: 314-694-4000 (collect calls accepted).

2. COMPOSITION/INFORMATION ON INGREDIENTS

Active ingredient

Isopropylamine salt of N-(phosphonomethyl)glycine; (Isopropylamine salt of glyphosate)

Component	CAS No.	% by weight (approximate)
Isopropylamine salt of glyphosate	38641-94-0	41
Surfactant	61791-26-2	8
Water	7732-18-5	51

Trade secret composition.

OSHA Status

This product is hazardous according to the OSHA Hazard Communication Standard, 29 CFR 1910.1200.

3. HAZARDS IDENTIFICATION

Emergency overview

Appearance and odour (colour/form/odour): / Liquid / Slight

WARNING:

Keep out of reach of children.

CAUSES SUBSTANTIAL, BUT TEMPORARY EYE INJURY

HARMFUL IF SWALLOWED

HARMFUL IF INHALED

REHABILITATION IS PROHIBITED

SEE INDIVIDUAL CONTAINER LABEL FOR REPACKAGING LIMITATIONS

MONSANTO Company
ROUNDUP ORIGINAL™ Herbicide

Version: 1.2

Effective date: 01/25/2001

Page: 2

Potential health effects

Likely routes of exposure

Skin contact, eye contact

Eye contact, short term

Causes temporary eye irritation.

Skin contact, short term

Not expected to produce significant adverse effects when recommended use instructions are followed.

Inhalation, short term

Not expected to produce significant adverse effects when recommended use instructions are followed.

Refer to section 11 for toxicological and section 12 for environmental information

4. FIRST AID MEASURES

Eye contact

Immediately flush with plenty of water.

Continue for at least 15 minutes.

If easy to do, remove contact lenses.

If there are persistent symptoms, obtain medical advice.

Skin contact

Wash affected skin with plenty of water.

Wash clothes before re-use.

Take off contaminated clothing, wristwatch, jewellery.

Inhalation

Remove to fresh air.

Ingestion

Immediately offer water to drink.

Do NOT induce vomiting unless directed by medical personnel.

If symptoms occur, get medical attention.

Advice to doctors

This product is not an inhibitor of cholinesterase.

Antidote

Treatment with atropine and oximes is not indicated.

5. FIRE FIGHTING MEASURES

Flash point

Does not flash.

Extinguishing media

Recommended: Water, dry chemical, carbon dioxide (CO₂), foam

Unusual fire and explosion hazards

None.

Environmental precautions, see section 6.

Hazardous products of combustion

Carbon monoxide (CO), nitrogen oxides (NOx), phosphorus oxides (P₂O₅)

Fire fighting equipment

NOTE: The MSDS shown here is for illustration purposes only. Do not rely on the information in this sample MSDS for the product described. Information may change. Obtain actual MSDS for each pesticide used on your farm from your chemical supply dealer or the pesticide manufacturer.

MONSANTO Company
 ROUNDUP ORIGINAL™ Herbicide

Version: 1.2

Page: 3

Effective date: 01/25/2001

Self-contained breathing apparatus.
 Equipment should be thoroughly decontaminated after use.

6. ACCIDENTAL RELEASE MEASURES

Personal precautions
 Use personal protection recommended in section 8.

Environmental precautions

SMALL QUANTITIES:
 Low environmental hazard.
LARGE QUANTITIES:
 Minimize spread.
 Keep out of drains, sewers, ditches and water ways.

Methods for cleaning up

SMALL QUANTITIES:
 Flush spill area with water.
LARGE QUANTITIES:
 Absorb in earth, sand or absorbent material.
 Dig up heavily contaminated soil.
 Collect in containers for disposal.
 Refer to section 7 for types of containers.
 Flush residues with small quantities of water.
 Minimize use of water to prevent environmental contamination.

Refer to section 13 for disposal of spilled material.

7. HANDLING AND STORAGE

Handling

Good industrial practices in house-keeping and personal hygiene should be followed.
 Avoid contact with skin and eyes.
 When using do not eat, drink or smoke.
 Wash hands thoroughly after handling or contact.
 Thoroughly clean equipment after use.
 Emptied containers retain vapour and product residue.
 Observe all labelled safeguards until container is cleaned, reconditioned or destroyed.
 Emptied containers retain vapour and product residue.
FOLLOW LABELLED WARNINGS EVEN AFTER CONTAINER IS EMPTIED.

Storage

Compatible materials for storage: stainless steel, aluminium, plastic, fibreglass, glass lining
 Incompatible materials for storage: galvanised steel, unlined mild steel, see section 10.
 Keep out of reach of children.
 Keep away from food, drink and animal feed.
 Keep only in the original container.
 Partial crystallization may occur on prolonged storage below the minimum storage temperature
 If frozen, place in warm room and shake frequently to put back into solution.
 Minimum shelf life: 5 years.

8. EXPOSURE CONTROLS/PERSONAL PROTECTION

Airborne exposure limits	
Components	Exposure Guide lines
Isopropylamine salt of glyphosate	No specific occupational exposure limit has been established.

MONSANTO Company
 ROUNDUP ORIGINAL™ Herbicide

Version: 1.2

Page: 4

Effective date: 01/25/2001

Surfactant	No specific occupational exposure limit has been established.
Water	No specific occupational exposure limit has been established.

Engineering controls
 Have eye wash facilities immediately available at locations where eye contact can occur.

Eye protection

If there is potential for contact:
 Wear chemical goggles.

Skin protection

If repeated or prolonged contact:
 Wear chemical resistant gloves.

Respiratory protection

No special requirement when used as recommended.

When recommended, consult manufacturer of personal protective equipment for the appropriate type of equipment for a given application.

9. PHYSICAL AND CHEMICAL PROPERTIES

These physical data are typical values based on material tested but may vary from sample to sample. Typical values should not be construed as a guaranteed analysis of any specific lot or as specifications for the product.

Form:	Liquid
Odour:	Slight
Flash point:	Does not flash.
Specific gravity:	1.1655 @ 20 °C / 15.6 °C
pH:	4.4 - 5.0
Partition coefficient (log Pow):	< 0.000 (active ingredient)

10. STABILITY AND REACTIVITY

Stability

Stable under normal conditions of handling and storage.

Hazardous decomposition

Thermal decomposition: No data.
 Hazardous products of combustion: see section 5.

Materials to avoid/Reactivity

Reacts with bases to liberate heat.
 Reacts with galvanised steel or unlined mild steel to produce hydrogen, a highly flammable gas that could explode.

Hazardous polymerization

Does not occur.

11. TOXICOLOGICAL INFORMATION

This section is intended for use by toxicologists and other health professionals.

Data obtained on product or on similar products are summarized below. Data obtained on active ingredient are summarized below.

NOTE. The MSDS shown here is for illustration purposes only. Do not rely on the information in this sample MSDS for the product described. Information may change. Obtain actual MSDS for each pesticide used on your farm from your chemical supply dealer or the pesticide manufacturer.

ties of the pesticide is found in this section. This includes appearance, odor, pH, and specific gravity.

Stability and Reactivity.

Unique hazards and stability information is included in this section. This information is useful to you when you are handling the pesticide as well as when you are storing it, because it points out proper procedures to follow.

Toxicological Information.

This is a very useful part of the Material Safety Data Sheet because it provides you with summaries of the health effects of the pesticide based on animal studies and on literature reviews. This is the section where you can find information on the long-term health effects of the chemical if this information is available.

Ecological Information. This

section reports the toxicological results of testing the pesticide on fish, birds, and other wildlife and provides you with information on some of the hazards of the pesticide on the environment.

Disposal Considerations.

Information on how you must properly dispose of residues, containers, and leftover or unusable

pesticide is given in this section. Before disposing, however, check local regulations.

Transport Information. The

transportation of some pesticides is regulated by the U.S. Department of Transportation. This section tells you the Department of Transportation shipping name, hazard classification, and label information, when this information is required.

Regulatory Information. This

section instructs you whom to notify and what reporting information is required in an emergency if the pesticide is subject to hazardous materials laws. You must follow this information in cases of spills or other emergencies.

REVIEW QUESTIONS

(answers found on page 88)

- Which of the following is the most important source of information available when you use pesticides?
 - The manufacturer's sales pamphlet
 - The material safety data sheet (MSDS)
 - The pesticide label
 - The county Agricultural Commissioner
- If a pesticide package is too small for all the label information, the information you need will be available from:
 - The UC Cooperative Extension office in your county
 - The manufacturer, upon request
 - The chemical dealer from which you purchased the pesticide
 - Supplemental labeling attached to the package
- If you fail to follow pesticide label instructions, you may be subject to:
 - Improved crop production
 - Serious legal penalties
 - Reprimand from the Department of Food and Agriculture
 - No important consequences
- Reading the label before purchasing a pesticide will provide you information on:
 - Whether the pesticide is registered for your intended use
 - Potential crop improvement
 - Ways to market your crop
 - How to assess crop damage
- Checking the pesticide label before mixing the material will help you understand:
 - When to throw away empty containers
 - The size and number of spray nozzles to use
 - Precautions you must take to prevent exposure
 - How to clean up a spill
- Why is it important to check the pesticide label for storage information?
 - To determine how high containers can be stacked
 - To learn the precautions that must be taken to prevent breakdown or contamination
 - To learn what to do with empty containers
 - To learn where to take containers for refilling
- Pesticides used in California must have registration numbers on their labels issued by:
 - The U.S. Department of Agriculture and the California Department of Food and Agriculture
 - The U.S. Environmental Protection Agency and the Regional Water Quality Control Board
 - The U.S. Environmental Protection Agency or the California Department of Pesticide Regulation
 - The U.S. Department of Agriculture and the California Department of Pesticide Regulation
- Restricted-use pesticides can only be applied by or used under the supervision of a:
 - County Agricultural Commissioner
 - University of California researcher
 - Certified Pesticide Applicator
 - Licensed Pesticide Dealer
- Information about the preharvest interval, if any, will be found in which of the following pesticide label sections?
 - Directions for use
 - Precautionary statements
 - Statement of use classification
 - Registration and establishment numbers

10. Which signal word indicates the *least* amount of hazard?
- Warning
 - Caution
 - Danger
 - Poison
11. For information on storing a pesticide, which part of the label would you check?
- The directions for use
 - The precautionary statements
 - The statement of use classification
 - The agricultural use requirements
12. A *planback restriction* is:
- The time before workers can enter the treated area after application
 - The time that must lapse after application before the crop can be harvested
 - A limitation on the crops which can be planted in an area where the pesticide has been applied
 - The number of days that must pass before workers can enter the field to plant a crop
13. In which section of the label will you find the personal protective equipment (PPE) requirements for pesticide handlers?
- The directions for use
 - The precautionary statements
 - The statement of use classification
 - The contents statement
14. Who of the following *is not* a pesticide handler?
- A person who mixes pesticides
 - A person who cleans contaminated equipment
 - A person who transports pesticides from the dealer to your farm
 - A mechanic who repairs an uncleaned sprayer
15. What is the usual *restricted-entry* interval for pesticides having the signal word CAUTION?
- 12 hours
 - 24 hours
 - 48 hours
 - When the spray dries or the dust settles
16. What is the usual *minimum* restricted-entry interval in California for an organophosphate insecticide with the signal word DANGER?
- 12 hours
 - 24 hours
 - 48 hours
 - 72 hours
17. Before making any pesticide application, who must you notify?
- Anyone working within $\frac{1}{4}$ mile of the application site
 - Employees working on your farm if they are working within $\frac{1}{4}$ mile of the treated area
 - Notification is not always necessary
 - The UC Cooperative Extension Farm Advisor
18. What should you do when the pesticide label does not specify which method to use to notify workers of a pesticide application?
- You must post the treated area
 - You must orally notify all employees about the application
 - You must post *and* orally notify all people working on your farm if they are working within $\frac{1}{4}$ mile of the application
 - You must notify, either orally or by posting, all employees working on your farm if they are working within $\frac{1}{4}$ mile of the application
19. If the pesticide label calls for a 48 hour restricted-entry interval, but California regulations require a longer interval, which should you use?
- The restricted-entry interval on the pesticide label
 - The California (longest) restricted-entry interval
 - An average between the two requirements
 - The interval on the label plus 50% the California interval

20. If you applied a pesticide with the signal word **CAUTION** to a field on the first of the month, what pesticide-related training must a picking crew receive if they begin work on the 26th of that month?
- No pesticide-related training is necessary
 - You must provide or verify the workers have received *pesticide handler* (PSIS A-8) training
 - Pesticide-related training is not required unless the workers are employed for more than 30 days
 - You must provide or verify that the workers have received the training for farmworkers (PSIS A-9)
21. Who is an *early-entry worker*?
- An employee who must enter a pesticide treated area to perform cultural activities before the restricted-entry interval expires
 - An employee who performs cultural activities in an area just before the pesticide is applied
 - An employee who performs cultural activities in a treated area during the 30-day period after the restricted-entry interval expires
 - Anyone who enters a pesticide-treated area any time during the current growing season
22. If a pesticide has a California Special Local Need (SLN) registration, it may:
- Not be used in California
 - Have additional uses or limitations than those listed on the pesticide label
 - Only be used on experimental crops
 - Only be used under the supervision of the county Agricultural Commissioner's office
23. Besides the pesticide label, information about a specific concentrated pesticide hazard can be obtained from:
- Manufacturer's literature
 - The Material Safety Data Sheet
 - Pest Control Advisor
 - The chemical distributor
24. If you were looking for information on what to use to clean up a pesticide spill, your best source of information would be:
- The county Agricultural Commissioner
 - The local fire department
 - The pesticide label
 - The pesticide Material Safety Data Sheet

Chapter 2

MIXING AND APPLYING PESTICIDES

APPLY

Pesticides are useful pest management tools only if you properly mix and apply them. As you know, pesticides are expensive materials. Most are hazardous chemicals that require special handling. In California, all pesticides are highly regulated, and you must handle them responsibly. Each time you apply any agricultural use pesticide, you must report its use to the agricultural commissioner. As a result of the costs and regulations, controlling pests with pesticides requires a lot of planning and paperwork. To be sure your efforts pay off, follow all label instructions and legal requirements (Figure 2-1). This chapter discusses methods of mixing, application, and calibration of application equipment that will help you get the greatest benefit from your time and investment.

MIXING PESTICIDES

Techniques for mixing pesticides are the same for large and

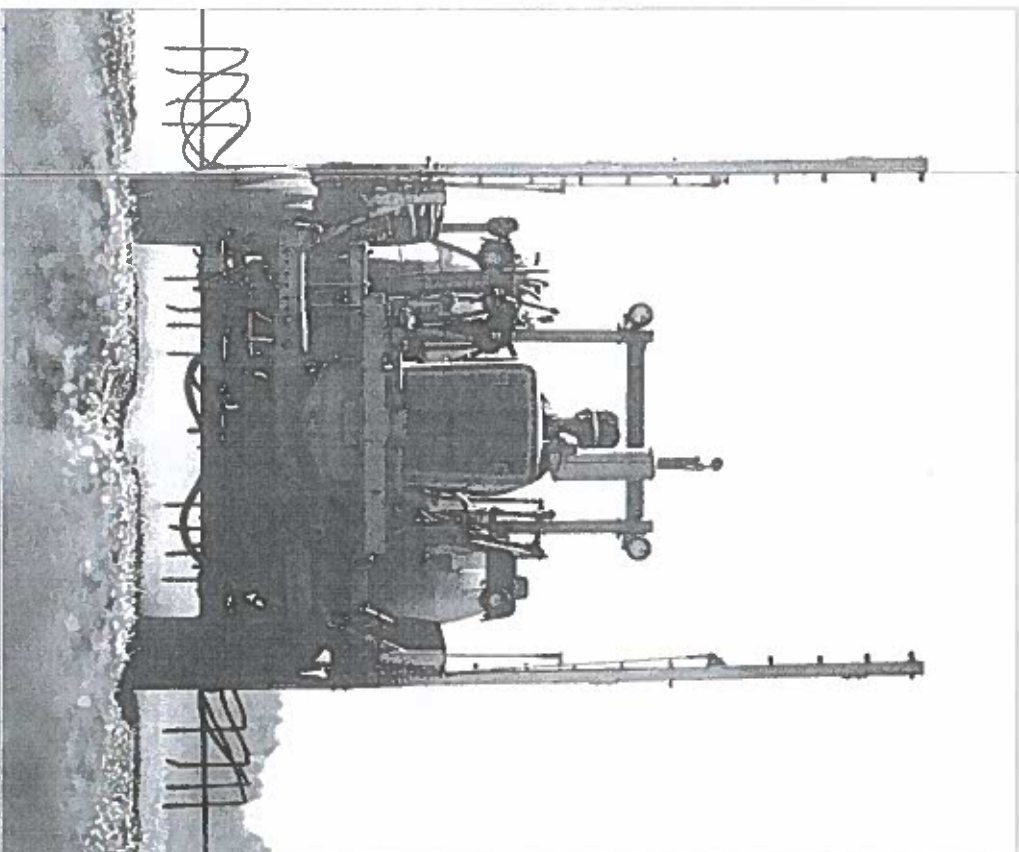

Figure 2-1. Pesticide applications involve time and expense. Get the most out of these investments by mixing pesticides properly and applying them at the correct rates.

small volumes: You must thoroughly incorporate the proper amount of pesticide into a measured amount of water (or other diluent).

Before beginning, read the mixing directions on labels of all pesticides you will be using (see the DIRECTIONS FOR USE section on the label) and decide on the proper order that chemicals should be



added to the spray tank. If *adjuvants* are needed, these are usually added before any pesticides unless label instructions give a different order. Mixing order is important to reduce incompatibility problems and assure a uniform mixture.

When combining pesticides of different formulations, add them to the spray tank in the following

order: (1) wettable powders; (2) flowables; (3) water-soluble concentrates; then (4) emulsifiable concentrates. For example, when combining a water-soluble concentrate with a wettable powder, always add the wettable powder to the spray tank first. When mixing an emulsifiable concentrate with a flowable, add the flowable first.

Determine what protective clothing will be needed for mixing and application by reading the PRECAUTIONARY STATEMENTS section of the label. Here you may find that different types of personal protective equipment are required for mixing than what you will use during application.

Before adding any pesticides to your spray tank, check your application equipment to be sure there are no cracked hoses or other leaks, and that the filters, screens, and nozzles are clean. Have an emergency supply of soap and clean water nearby for washing in case of an accident.

The water you use to fill a spray tank should look clean enough to prevent damage to application equipment and be free of sand, dirt, algae, or other foreign matter.

Sand or dirt causes excessive wear on pumps and nozzles and clogs filters, screens, and nozzles. Algae may clog filters and nozzles and can react with some pesticides to reduce their effectiveness. Do not use the water if you detect any chemical odors. Chemicals may react unfavorably with some pesticides. For example, chlorine used in domestic water supplies for control of bacteria combines with some pesticides and reduces their effectiveness. High levels of dissolved salts (alkaline or *hard water*) causes deactivation of pesticides and may even damage treated foliage.

If possible, do a simple pH test on the water using a swimming pool test kit or similar testing device. High pH (alkaline water) causes hydrolysis, or breakdown, of many pesticides before you can spray them onto the target surfaces. Add a buffer or acidifier if the pH is too high (check with the label or your pest control dealer for an appropriate adjuvant to do this). When you have any doubts about the water quality, locate another source for filling your spray tank.

Measure pesticides carefully, accurately, and safely. Inaccurate measuring can produce large errors

in the amount of pesticide being applied and may cause serious problems. For instance, sulfonurea herbicides are applied at rates of $\frac{1}{2}$ to $\frac{1}{4}$ ounce of formulated material per acre; small inaccuracies in measuring can produce gross errors in application rates.

Your employees must use a closed mixing system when mixing, loading, diluting, or transferring liquid formulations of pesticides with the signal word *Danger* (Figure 2-2). They must also use closed systems when loading or transferring diluted

liquid mixes derived from dry formulations of pesticides with the signal word *Danger*.

Closed mixing systems enable accurate and safe measuring of pesticides being put into the spray tank. The closed-system requirement does not apply if employees handle one gallon or less of liquid formulations with the signal word *Danger* per day and the liquid pesticide is in an original container of one gallon or smaller. See the Pesticide Safety Information Series A-3 for legal requirements of closed mixing systems.



Figure 2-2. Your employees must use a closed mixing system when mixing or loading liquid formulations of pesticides with the signal word *Danger*.

Measuring. Liquids and some granular pesticides are measured by volume, while dusts, powders, and most dry formulations are measured by weight. Pesticide labels use the English system of measurement: liquid volumes are in fluid ounces, pints, quarts, and gallons; dry weights are in pounds and ounces.

You will need an assortment of glass or plastic calibrated measuring utensils, from one ounce to one gallon, for accurately measuring liquids unless you use a closed mixing system. Some pesticides react with metal, especially aluminum and iron, so avoid using any metal measuring utensils. Use an eyedropper to measure small quantities of liquid. Use an accurate scale and a set of measuring cups and spoons for measuring and weighing dry pesticides (Figure 2-3).

You must use scales and liquid measuring vessels that are calibrated to the smallest unit of weight or measure that you will be using. For example, you cannot use a measuring device that is calibrated in 2-ounce graduations to accurately measure $\frac{1}{2}$ ounce of liquid.

Some measuring equipment can be mistaken for kitchen utensils, so identify all your pesticide measuring utensils in a very obvious manner. Paint handles with brightly colored waterproof paint or attach waterproof labels to each utensil. When not being used, keep all measuring and weighing equipment locked in the pesticide storage area so it cannot be used for other purposes. Clean and wash utensils before they are stored to prevent contaminating future mixtures.

Pesticide Packaging. Pesticide packages are available in different units of weights or volumes. Whenever possible, plan a mixture

that uses an even, preweighed amount of pesticide. Your unit cost may be greater when you purchase pesticides in smaller packages, but this disadvantage can often be minimal compared to the convenience and added safety of not having to weigh or measure hazardous chemicals. Do not open water-soluble packets since this defeats the safety of this type of packaging (Figure 2-4). Instead, calibrate application equipment so you can use the entire packet or a number of whole packets.

Mixing Location. Select a mixing location that can be cleaned easily should an accident occur. Consider the surroundings and the environmental impact of the mixing site.

Measure and weigh chemicals in a clear, open area. If outdoors, stand upwind to reduce chances of exposure. Wear a dust/mist respirator or cartridge respirator approved for pesticide use while weighing and mixing dry pesticides to prevent inhaling dust. Protect your hands and clothing with waterproof gloves and appropriate outerwear.

Liquids are easily spilled and splashed, so wear a rubber apron. Refer to the **PRECAUTIONARY**



Figure 2-4. Water-soluble packages protect you from hazardous powders.

STATEMENTS section of the pesticide label for the specific protective clothing and equipment you will need for mixing and loading pesticides. A faceshield, goggles, or other protective eyewear and rubber gloves must be worn by employees engaged in mixing, however, even if the requirements are not on the pesticide label.

Reduce chances of spills or splashes into your face and eyes by always measuring and pouring pesticides *below* eye level.

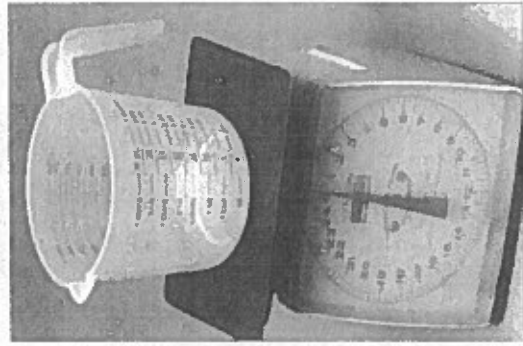

Figure 2-3. A scale and calibrated measuring utensils are necessary for accurate measuring and weighing of pesticides.

See the appendix page 106 for Procedures for Triple Rinsing Pesticide Containers.



Steps for Mixing

Begin mixing by filling your spray tank at least half full with clean water. To allow room for the pesticide, adjuvants, and residues from triple rinsing of containers, avoid filling the tank more than $\frac{3}{4}$ full. Check and adjust the pH of the water in the spray tank at this time. Start the agitators if the equipment has them.

Open pesticide containers carefully to prevent spilling and to make resealing easier. Cut open paper containers with a sharp knife or scissors, rather than by tearing. Metal containers, glass and plastic bottles, and plastic pails all have protective seals that you must break open before use. Most of these containers can be resealed easily with screw caps.

After measuring or weighing the correct amount of pesticide, carefully pour it into the partially filled spray tank. Rinse the measuring container and then pour the rinse solution into the spray tank. Use caution while rinsing to prevent splashing. Many closed mixer systems are equipped with container rinsing devices that pump the rinse solution into the pesticide tank. Unless they are rinsed automatically, you should drain liquid pesticide containers into the spray tank for 30 seconds after they have been emptied, then rinse and drain the containers three more times (triple rinsed).

After each draining, fill the container about $\frac{1}{4}$ full of water, put the cap back on and shake for several seconds to mix the residue with water. *Pour each rinse solution into the spray tank.* Containers that have been triple-rinsed do not have to be transported to special disposal sites but can be recycled (as pesticide containers, not through general recycling channels) or taken to a Class 2 disposal sites where they might be inspected for cleanliness.

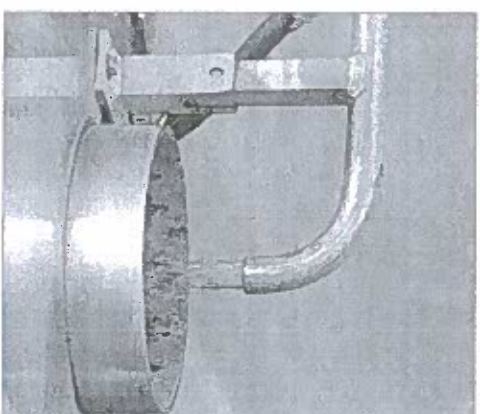

Figure 2-5. An air gap prevents back siphoning while filling a spray tank.

Once the pesticide has been added, fill your spray tank to its final volume. Do not allow the tank to overflow during filling, and *never* let the hose, pipe, or other filling device come in contact with liquid in the tank. If the tank is being filled through a top opening, you must provide an *air gap* equal to at least twice the diameter of the filling pipe between the liquid in the spray tank and the filling device (Figure 2-5).

This gap will protect the water source by preventing siphoning of the spray mixture back into the water supply after the water flow is stopped. If you have a side- or bottom-filling system, you are required to use a *back-flow prevention device* to prevent back-flow of pesticides from the spray tank into the water supply.

APPLYING PESTICIDES EFFECTIVELY

To use pesticides safely and effectively, you have to make sure that all the pesticide is applied to the treatment area and in the proper amount. Pesticide coverage usually must be uniform. For example, both sides of leaf surfaces need to be coated with pesticide droplets for

adequate control of some plant-feeding insects or mites. Sprays improperly aimed at the foliage may cause *shingling*, a condition in which leaves clump together and prevent droplets from reaching some leaf surfaces. Using an air blast sprayer or oscillating boom sprayer produces *ruffling* of the plant foliage and enables spray droplets to contact all surfaces (Figure 2-6).

Spills, leaks, and drift not only waste material, they may cause pesticides to get into nontarget areas. Improperly calibrated equipment causes too little or too much pesticide to reach the target site. Safe applications require that you use the proper equipment, develop good application techniques, reduce or eliminate drift, and have an awareness of potential hazards.

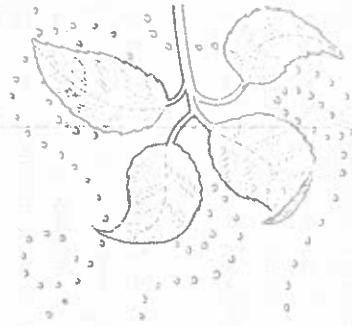
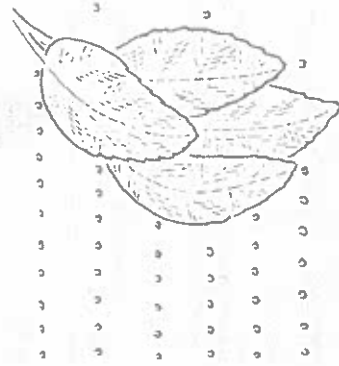

Figure 2-6. Improperly aimed sprays may cause shingling and result in poor coverage as shown in the left drawing. Air blast sprayers produce ruffling, allowing for good coverage of spray droplets, as shown at right.

Selecting Application Equipment

The equipment you use to apply pesticides on your farm must be suited to the locations and conditions of the treatment area. Equipment that is too big or too powerful may be as much of a problem as equipment that is too small. Most pesticide application equipment is designed to work efficiently only in a limited number of situations. Some conditions require that the spray be moved to target surfaces with a blast of air to improve coverage.

Choose application equipment that is easy to use and comfortable to work with. Before buying equipment, whether it be new or used, consult with pest control dealers, UC Cooperative Extension Service farm advisors, and other experts who are familiar with your farming operation to be sure the equipment will be suitable for your needs. Calibration of any equipment must be easy for you to do or it will never be accurate. Equipment should be simple for you to repair, and parts should be readily available. Select hand-held equipment that is lightweight so that it is convenient for you to use.

see appendix page 90
for a Checklist for
Planning a Pesticide
Application.

Motor powered units should be quiet enough to prevent operator stress, yet powerful enough to do the job properly. Moving parts need shields and guards to prevent accidents and injuries. Powered equipment must have accurate gauges so you can monitor spray pressure and other functions.

Pesticide application equipment has to be durable because using this machinery on your farm may subject it to long hours of operation. Make sure that the filler cover on the spray tank closes properly and seals well (Figure 2-7). If your spray tank will be left unattended, lock the cover. Hoses and fittings should be strong and durable to prevent leaks and possible environmental contamination. Leaks or ruptures could cause you to be seriously injured.



Figure 2-7. Tank covers must be tight fitting and seal well.

Safe Application Techniques

Safe application techniques require that you work with the weather, control droplet size and deposition, be familiar with the application site, and have an awareness of its hazards. Develop special application patterns for the site to accommodate hazards and environmental conditions, and leave buffer zones to protect sensitive areas.

Working with the Weather.

Weather influences pesticide applications. Temperature affects the *phytotoxicity* of certain pesticides, so label DIRECTIONS FOR USE will usually warn you against using these products when temperatures are above or below critical limits. Many pesticides break down or volatilize rapidly when temperatures are high. Pesticides also may break down rapidly by exposure to ultraviolet light, which is most intense during clear, sunny weather.

Air temperature is responsible for the inversion phenomenon, which may often cause serious, yet invisible, pesticide drift (Figure 2-8). Inversions occur when the air 20 to 100 or more feet above the

ground is warmer than the air below it. The warm air layer forms a cap that blocks vertical air movement. To detect a temperature inversion, observe a column of smoke rising into the air. Smoke from burning may be easy to see, but check with local air quality

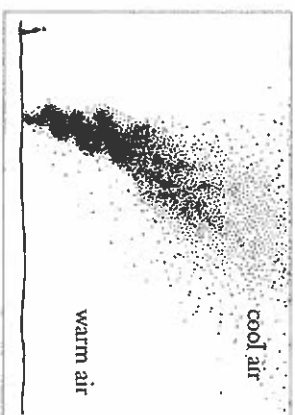

NORMAL CONDITION—
SMOKE RISES AND DISPERSES

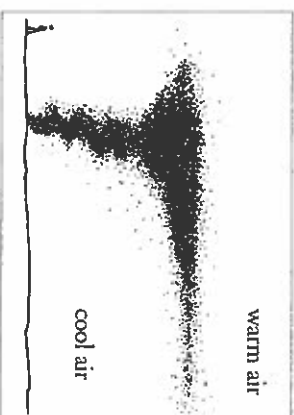

INVERSION CONDITION—
SMOKE CONCENTRATES

Figure 2-8. Temperature inversions can cause serious offsite movement of pesticides.

authorities to be sure such burning is permissible and to find out if inversion conditions may be present. If the smoke begins moving

sideways or collects in one area a few hundred feet above the ground, an inversion condition probably exists.

Inversion conditions are dangerous during a pesticide application because fine spray droplets and pesticide vapor can become trapped and *concentrated*, similar to the smoke column. Rather than dispersing, the pesticide often moves as a concentrated cloud away from the treatment site.

Honey bees only forage during certain temperature ranges; therefore, make applications when temperatures are not suitable for bee activity (early mornings or late afternoons) if you are using pesticides that might injure bees.

Rainfall, fog, and even heavy dew affect pesticide applications because the moisture dilutes and degrades pesticides and may wash the material off treated surfaces. Rainwater washes pesticides into the soil, producing possible groundwater and surface water contamination. Pesticides can also be carried away from the application site through water movement after heavy rains or irrigation (runoff).

Wind influences pesticide drift and also has an effect on volatilization (the evaporation of the pesticide). Strong air movements are responsible for uneven pesticide deposition, although some air movement (up to 5 miles/hour) has advantages in getting good coverage of treated surfaces.

Controlling Droplet Size and Deposition. Spray droplet *deposition* is influenced by droplet size, the pressure of the spray stream, the force and volume of the air, if any, used to distribute spray, and the speed of travel of the application equipment. Droplet size depends on nozzle size, style, and condition, combined with spray volume, spray pressure, and weather influences. Your application equipment probably emits a spray with a wide range of droplet sizes, even though the best spray applications result from applying uniform-sized droplets evenly to all treated surfaces. You can increase the uniformity of spray droplets (and effectiveness of your spray application) by selecting nozzles designed for the working pressure and volume of your application equipment and by replacing worn or defective nozzles.

The type of application equipment you use must be suitable for the physical and environmental features of your field location. Application speed is critical and should be adjusted to the

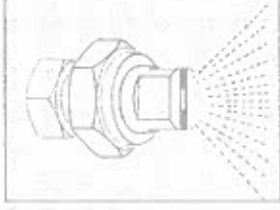

type and size of the area being treated. Slower speeds are usually required when spraying large trees and vines, because spray droplets must travel farther and more volume is required to cover larger surface areas.

Site Characteristics and Environmental Hazards. Before beginning a pesticide application, check the physical characteristics of the terrain and note all potential hazards. Check for organisms or structures that might be damaged by pesticides or water or by the physical movement of the equipment through the area. Ditches, embankments, steep slopes, electrical wires, and electric fences can pose hazards to you or your equipment.

Application Pattern. An application pattern is the route you follow while applying a pesticide (Figure 2-9). The purpose of any

application pattern is to provide an even distribution of pesticide over the treated area and to avoid overlaps or gaps. Pesticide application speed usually determines the uniformity of the application pattern. At higher speeds, the equipment bounces more; with airblast sprayers, the volume of displaced air is reduced as travel speed increases. The pattern used for pesticide application must take into consideration prevailing weather conditions, what is being sprayed, and hazards in or near the application site. Patterns should also be designed to eliminate the need for you to travel through airborne spray.

Operating equipment (such as boom applicators) during turns produces an uneven application and can result in illegal pesticide residues off treatment sites. Also, watch for clogged nozzles that will produce uneven applications. Because it is difficult to see clogging when using soil injection equipment, you may need to check injectors frequently or install a simple bypass system that will let you monitor the flow to each nozzle.

Buffer strips should be left unsprayed when a treatment area adjoins locations where animals,

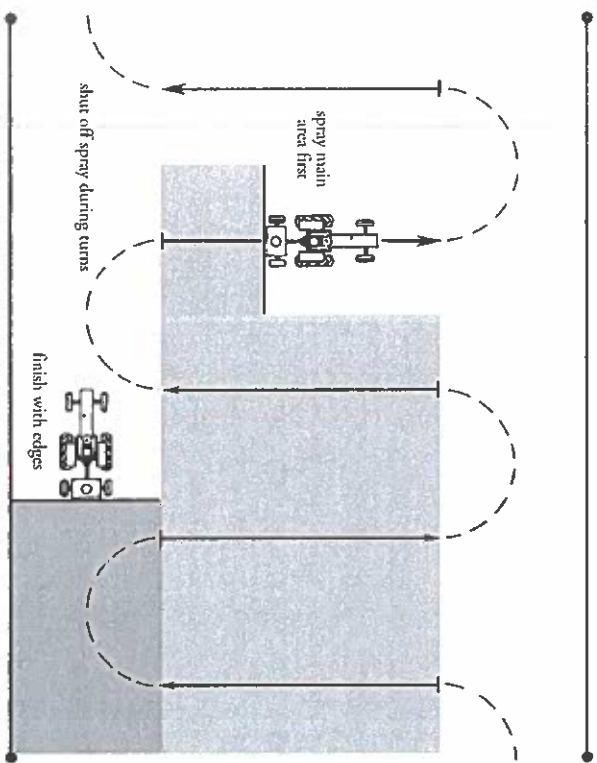

Figure 2-9. Before beginning to apply a spray, decide on the application pattern. Shut off spray nozzles during turns to avoid uneven applications. After spraying the main part of the field, finish by spraying the edges.

people, or structures might be harmed by pesticide exposure. The size of the buffer strip depends on the type of application equipment being used, prevailing weather conditions, the nature of pesticide being applied, the type of pest problem being treated, and the sensitive nature of adjoining areas. As a general rule, the buffer should be no less than the width of one spray swath. County agricultural commissioner permit conditions may contain chemical or site specific buffer distances.

Pesticide Drift

Pesticide drift refers to the movement of pesticides away from the treatment site. Drift is most serious when you make applications during windy conditions, especially while using high pressure and small nozzle sizes. Spray droplets intended for a specific treatment area may be carried away through the air to other locations. Another form of drift occurs when sprayed pesticides partially evaporate (or volatilize) before reaching

the target. The resulting vapor can drift away from the treatment area through air movement, often traveling several miles.

There are steps you can take to reduce problems with drift. Eliminating very small droplets can significantly reduce drift. Droplet size is increased if you use larger nozzles and lower the output pressure of the sprayer. You can also add adjuvants, called deposition aids, to your spray tank. These will assist in increasing spray droplet size or reducing evaporation potential.

Do not spray during windy conditions. Usually, winds less than 5 miles per hour help provide good pesticide distribution in trees and leafy plants, especially if your sprayer is not equipped with a blower. Stronger winds, however, will increase drift potential. In some cases, spraying may be illegal if the wind speed is over a designated rate. Check the pesticide label and with the agricultural commissioner for wind speed restrictions or requirements. Contact your agricultural commissioner for information on any pesticide application restrictions during windy or other local conditions.



Other weather conditions, such as a temperature inversion, also promote drift of small droplets and vapors. High temperatures and low humidity increase the evaporation rate, which will reduce the size of droplets before they reach their target. The resulting smaller droplets may be highly subject to drift.

Timing Your Applications for Effective Pest Control

The timing of an application is important for good control of target pests as well as protection of natural enemies and beneficial insects. Because some pesticides are more effective than others at controlling different life stages of the target pest, you should time your pesticide application to coincide with the most susceptible stage. Understanding the biology of the pest will help you deter-

mine its susceptible life stages and decide if a pesticide application will be effective.

The life stage of nontarget plants in the treatment area is another important consideration. Some herbicides, for example, may be toxic to crop plants as well as weeds once the crop plants have reached a certain growth stage. Check pesticide labels for precautions on using herbicides during inappropriate life stages of nontarget plants.

Whenever possible, avoid injury to *nontarget organisms* by timing applications to periods when they are not present in the treatment area. This technique works well for honey bees because they forage only during warm, daylight hours; if you apply pesticides during the early morning, late afternoon, or on cold and cloudy days you will usually reduce hazards to honey bees.



Insecticides applied while trees are dormant may be less damaging to some natural enemies of pests. However, injury to nontargets as a result of run-off of dormant sprays has been a problem.

EQUIPMENT CALIBRATION

The term *calibration* refers to all the adjustments you make to your equipment that ensure the correct amount of pesticide is applied to the treated area. Failure to calibrate equipment properly is a frequent cause of ineffective pesticide applications and always carries the potential for excessive or illegal residues remaining on sprayed surfaces.

When you calibrate your application equipment you determine how much pesticide must go into the spray tank to assure that the correct amount of chemical gets applied. This is necessary for (1) effective pest control; (2) protecting human health, the environment, and treated surfaces; (3) preventing waste of resources; and (4) compliance with the law.

Effective Pest Control. Manufacturers of pesticides research ways to use their products, including determining the correct amount of pesticide required for effective control of target pests. If you use less than the labeled amount of pesticide you may experience inadequate control, and waste your time and money.

Despite this, several recent studies show that a third of all pesticide applicators unknowingly under-apply pesticides by an average of 30%. Inadequate amounts of pesticides lead to problems such as pest resistance and resurgence. One third of all applicators over-apply pesticides, averaging 35% more pesticide than the maximum label rate. Using too much pesticide has adverse effects on natural predators, target surfaces, and the environment, wastes materials, and is illegal.

Human Health Concerns. If you apply pesticides at rates or frequencies higher than label recommendations you may endanger human health. Illegal residues may occur on produce when a pesticide is over-applied. Your entire crop may be confiscated to protect consumers. Even if pesticide residues

are legal, over-application could result in your produce being seized and enforcement action.

Workers in your fields may receive unnecessary exposure to residues resulting from an over application. You can be exposed to more concentrated and dangerous mixtures of pesticide when the equipment is poorly calibrated or nozzles are severely worn.

Environmental Concerns. The pesticides you use on your farm may cause environmental problems such as groundwater and surface water contamination if you fail to use them properly. Avoid harm to beneficial insects, such as honey bees, and to wildlife by carefully calibrating your equipment to maintain application rates within label recommendations.

Protect Treated Plants. Certain pesticides are phytotoxic and can damage sensitive plants. Manufacturers evaluate these potential problems while testing their chemicals. Therefore, never apply more than the labeled amount of pesticide. Chances of building up excessive residues in the soil are also increased when you use too much pesticide. This may serious-

ly limit the types of subsequent crops that you can grow in an area.

Prevent Waste of Resources. Using the improper amount of pesticide wastes your time and adds unnecessary costs to your application. Not only are pesticides expensive, but the fuel, labor, and equipment wear and tear required to make extra applications are costly too.

Legal Aspects. If you use or contract for the use of pesticides improperly you may be subject to criminal and civil charges, resulting in fines, imprisonment, and lawsuits. You are liable for injuries or damage to people, the environment, crops, and personal and public property caused by improper pesticide application.



CALIBRATING YOUR APPLICATION EQUIPMENT

Begin by measuring the exact size of the treatment area. This will allow you to determine the amount of pesticide you will need for the job and will avoid problems of leftover mixtures and what to do with them. Follow the instructions on page 56 to measure the size of your treatment area.

To determine how much pesticide to put into your spray tank to make the correct rate of application, you will need to measure four things: (1) the capacity of your spray tank; (2) your speed of travel; (3) the combined output rate of the nozzles; and (4) the swath width. Use the *Calibration Information Sheet* on page 50 to record your measurements and make your calculations.

The equipment you are calibrating should be filled with clean water or blank granules. However, pesticide application equipment and the discharge from application equipment being calibrated may contain pesticide residues. Always wear rubber gloves and other protective equipment to

prevent pesticide contamination of your eyes, hair, skin, clothing, and shoes.

Calibrating Liquid Application Equipment

Equipment designed to apply pesticides dissolved or suspended in water needs to be calibrated frequently. This will allow you to monitor pump and nozzle wear. Pump wear may decrease the amount and pressure of fluid output. Nozzle wear increases the volume of output, may lower the output pressure, and may produce a poor spray pattern. Abrasive pesticides, such as wettable powders, increase the rate of wear. Water-soluble formulations produce the least amount of wear.

Wear rubber gloves to avoid skin contact with liquid pesticide mixtures (even when calibrating with water only), as residues may remain in the spray tank. Stand upwind from the nozzles or other orifices to prevent fine mist or spray from contacting your face and clothing. Wear eye protection to prevent getting spray droplets into your eyes.

Appendix page 109 contains a table of Useful Conversion Factors for Calibration.

CALIBRATION INFORMATION SHEET

APPLY

STEP 1. Measure the capacity of the tank.

$$\text{TANK CAPACITY} = \text{_____ GALLONS}$$

(use this figure in step 7)

STEP 2. Measure the speed of travel.

- Distance traveled = _____ feet
- Time to travel distance = _____ minutes

DIVIDE DISTANCE (a) BY TIME (b):

$$\text{DISTANCE} \div \text{TIME} = \text{_____ FEET PER MINUTE}$$

(use this figure in step 5)

DIVIDE FEET PER MINUTE BY 88 FEET PER MINUTE:

$$\text{FEET PER MINUTE} \div 88 = \text{_____ MILES PER HOUR}$$

(this figure for information only)

STEP 3. Measure flow rate of nozzles.

- Fluid collected from each nozzle = _____ ounces
- Time to collect fluid = _____ seconds

DIVIDE OUNCES (a) BY SECONDS (b):

$$\text{OUNCES} \div \text{SECONDS} = \text{_____ OUNCES PER SECOND}$$

MULTIPLY OUNCES PER SECOND BY 0.4688:

$$\text{OUNCES PER SECOND} \times 0.4688 = \text{_____ GALLONS PER MINUTE}$$

(use this figure in step 6)

STEP 4. Measure swath width.

$$\text{SWATH WIDTH} = \text{_____ FEET}$$

(use this figure for step 5)

STEP 5. Area treated in 1 minute.

$$\text{DIVIDE 43,560 FEET PER ACRE BY SWATH WIDTH:}$$

$$43,560 \div \text{SWATH WIDTH} = \text{FEET PER ACRE}$$

DIVIDE FEET PER ACRE BY FEET PER MINUTE:

$$\text{FEET PER ACRE} \div \text{FEET PER MINUTE} = \text{_____ MINUTES PER ACRE}$$

(use this figure in step 6)

STEP 6. Calculate gallons applied per acre.

MULTIPLY THE GALLONS PER MINUTE TIMES THE MINUTES PER ACRE:

$$\text{GALLONS PER MINUTE} \times \text{MINUTES PER ACRE} = \text{_____ GALLONS PER ACRE}$$

(use this figure in step 7)

STEP 7. Calculate acres treated per tank.

DIVIDE TANK CAPACITY BY GALLONS PER ACRE:

$$\text{TANK CAPACITY} \div \text{GALLONS PER ACRE} = \text{_____ ACRES PER TANK}$$

(use this figure in step 8)

STEP 8. Calculate the amount of pesticide to put into the tank.

WRITE LABEL RATE PER ACRE HERE: _____
(pounds per acre, quarts per acre, gallons per acre, etc.)

MULTIPLY LABEL RATE BY ACRES PER TANK:

$$\text{LABEL RATE} \times \text{ACRES PER TANK} = \text{_____ PER TANK}$$

(pounds, quarts, gallons, etc.)

Tank Capacity

(Tools and supplies needed: Calibration Information Sheet and containers of known volume or flow meter.)

Tank volumes for various types of pesticide application equipment used on your farm may vary in capacity from a few gallons to several hundred gallons. For accurate calibration, it is essential you know the exact volume of the tanks. Never rely on manufacturer's ratings, because these could be approximate volumes or may not take into account fittings or agitation devices installed inside the tank or the capacity of spray lines, pump, and filters.

You need to measure the capacity of the spray tank only one time. Once you have accurately measured the volume, write this figure on the side of the tank using an indelible marker. Also note the tank volume on the *Calibration Information Sheet*. Later, if you modify the sprayer and add or delete hoses, lines, filters, or any other parts that hold some of the spray liquid, remeasure the volume of the tank.

For small-capacity sprayers, fill the tank with water using a cali-

brated container or other container of known volume. Always use clean water for measuring the volume of the spray tank. The spray tank should be perfectly level during filling. Close all valves to prevent the water from leaking out.

For larger tanks, install a flow meter onto the filling hose. Be sure to calibrate the flow meter first to ensure its accuracy. Do this by measuring water discharged by the flow meter into the calibrated container or other container of known volume. Compare the measured discharge to the reading of the flow meter.

Tanks with a capacity of more than 49 gallons are required to be equipped with an external sight gauge or a device that will automatically stop the filling operation before the pesticide liquid mixture spills over the top.

While filling the tank, calibrate the sight gauge by making marks on the tank or gauge as measured volumes of water are added. For sprayers with less than 50 gallons that are not equipped with sight gauges, mark volume increments on a dipstick and keep this with the tank at all times. Use 1-gallon

marks for tanks with a capacity of 10 gallons or less and increments of no less than 5 or 10 gallons for tanks having a total capacity of 50 gallons or less. Increments of 10 to 20 gallons may be used on larger tanks. Mark and record the maximum volume of the spray tank.

Some of your spray tanks may be made of a polypropylene material that is semitransparent. This material allows for visual monitoring of the fluid level inside the tank. Visual inspection, however, is no substitute for accuracy. You must still measure the tank as explained above to determine its precise volume.

Once the tank is calibrated and labeled, it will be easy for you to know exactly how much liquid is in the tank when the tank is not entirely full. Remember to put the tank on a level surface when reading the sight gauge or dipstick.

Speed of Travel

(Tools and supplies needed: 100-foot tape measure, stopwatch, Calibration Information Sheet, calculator.)

Always measure your travel speed under actual working conditions (Figure 2-10). Fill the

tank half full with water so the weight of the load will be an average of the weight in an actual application. Proceed at the speed you will be traveling when you make the application. Be sure to travel through the same area you will be treating.

Do not rely on the speedometer of the tractor to indicate actual speed. There are many variables that may cause as much as a 40% difference in actual versus indicated speed.

Once you have selected a route to follow through the area to be treated, mark off a measured distance. Your speed calibration will be more accurate if you mark off 200 to 300 feet than if a shorter distance is used to calibrate the unit speed. Use colored surveyor's tape to indicate the beginning and ending of the test course. Tie the tape to trees or stakes along the course so they are visible as you travel the measured distance. Record this distance on the *Calibration Information Sheet*. Be sure to leave at least 50 feet of distance at each end of the course so you have room to turn the equipment, safely come to a halt, or bring the equipment up to

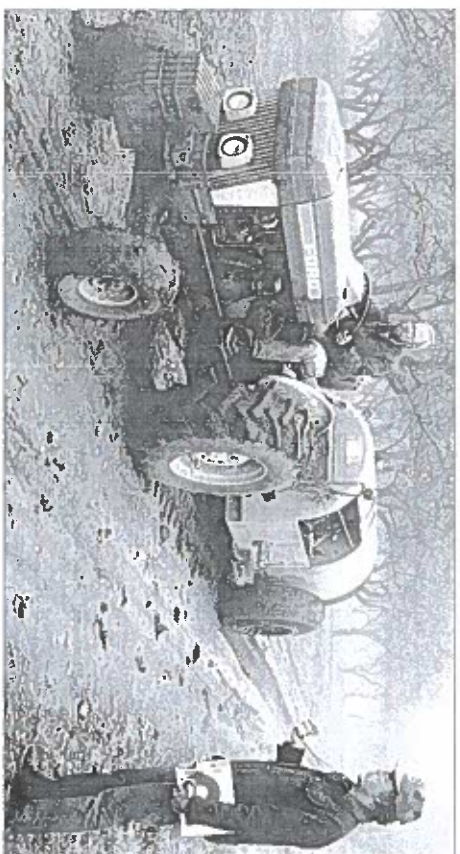

Figure 2-10. Travel speed should always be measured under actual field conditions with the spray tank half filled with water.

proper speed before entering the measured area.

Drive the sprayer through the measured distance at the speed desired for an actual application. Choose a speed within a range appropriate for the application equipment. Be sure you reach the actual application speed before crossing the first marker. Note the rpm and gear settings of the tractor so these settings can be duplicated during the actual application.

Use a stopwatch to measure the time it takes to travel the measured distance. Measure this time as accurately as possible and record it on the Calibration Infor-

mation Sheet. Turn around and repeat this process one or two more times, then average the results. If any of the times are significantly different than the others, consider throwing out that time and taking another measurement. Convert seconds into fractions of a minute by dividing the total number of seconds by 60. Using the information on the Calibration Information Sheet, divide the average time into the distance traveled. This will give you a rate of speed in feet per minute. Next, convert this into miles per hour by dividing it by 88 (1 mile per hour equals 88 feet per minute).

Flow Rate

(Tools and supplies needed: stopwatch, pressure gauge, calibrated container or flow meter, Calibration Information Sheet.)

Flow rate is the amount of spray material discharged from your sprayer over a given time, usually expressed in terms of gallons per minute. Flow rate is determined differently for your low-pressure sprayers than it is for your high-pressure sprayers with multiple nozzles. The two methods for establishing flow rate are presented here. The actual output of sprayer nozzles must be measured, and then the output must be checked periodically to determine if wear has affected the flow rate.

Although manufacturers provide charts showing output of given nozzle sizes at specified sprayer pressures, you should

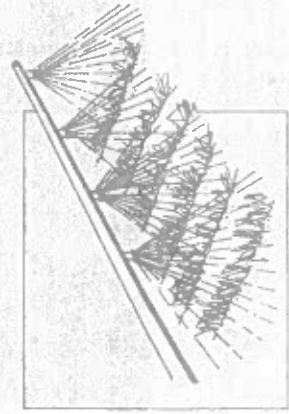

check output under actual conditions of operation. Manufacturer's charts are most accurate when using new nozzles. However, even new nozzles may have slight variations in actual output. Your sprayer's pressure gauge may not be accurate, adding further error to the output estimate determined from charts.

Collection Method for Low-Pressure and Small Hand-Held Sprayers. Low-pressure sprayers, including low-pressure boom sprayers and backpack sprayers, can be calibrated by measuring the amount of spray emitted from the nozzles. Use your stopwatch and collect the liquid from each nozzle into a calibrated container. If your sprayer is equipped with more than one nozzle, collect liquid from each separately to get a comparison of their outputs. This operation will point out uneven flow rates from malfunctioning or worn nozzles.

For your low-pressure power sprayer, fill the tank at least half full with water, start the sprayer, and bring the system up to normal operating pressure. Start the hydraulic agitators, if they are to be used during the application,

because hydraulic agitators divert some liquid from the nozzles and often lower the pressure in the system.

Your power sprayer will have a limited operating pressure range depending on the type of pump and type of power unit used. Never attempt to operate this equipment beyond its normal working range. Operating beyond the working range can cause premature failure of the pump.

Adjust the pressure to the requirements of the spray situation and nozzle manufacturer's recommendations. Be sure the correct nozzles are installed on the equipment. Check the pressure by attaching a calibrated pressure gauge at either end of the boom, replacing one of the nozzles. Open the valves to all nozzles and note the pressure, make adjustments as necessary, then remove the gauge and replace the nozzle. Record the operating pressure from the permanently installed gauge on the sprayer on the *Calibration Information Sheet*. Remember that changes in pressure will affect flow rate.

While all nozzles are operating

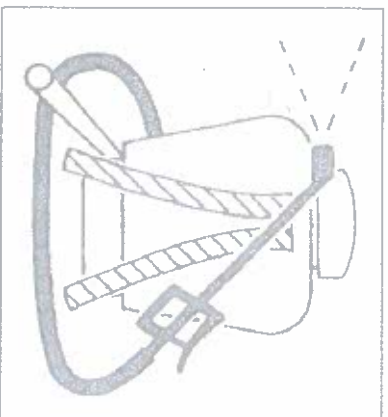

at the proper pressure, collect about 15 to 30 fluid ounces of liquid from each. Use a stopwatch to determine the time in seconds to collect each volume.

When calibrating your backpack sprayer, pump the unit as you would during an actual application. Collect spray into a calibrated container for a measured period of time. Compressed air sprayers lose pressure during operation, so they must be pumped frequently. Fill the tank about half full with water for this measurement to provide a sufficient volume of air to keep the pressure more uniform.

Record the volume of liquid collected from each nozzle or orifice on the sprayer you are calibrating and the time in seconds required to collect each amount. You will add the output from each nozzle, but first, determine the

fluid-ounces-per-second output for each nozzle by dividing the volume by the seconds required to collect it. Convert ounces-per-second into gallons-per-minute by multiplying the result by the constant 0.4688 (60 seconds per minute divided by 128 fluid ounces per gallon equals 0.4688).

Output among nozzles will usually vary. The variation among nozzles should not be greater than 5 percent, and the output of any nozzle should not exceed the manufacturer's rated output by more than 10 percent. If you discover any variation among the nozzles on the spray boom to be greater than these values, replace the defective or worn nozzles.

Whenever any nozzles are replaced, the flow rate of all the nozzles must be rechecked. Changing one nozzle may affect the pressure in the whole system. After changing nozzles, readjust the pressure regulator to maintain the desired pressure.

Determining Flow Rate of High-Pressure Sprayers. Your high-pressure sprayer requires a different technique to measure flow rate, since it is difficult or

impossible to collect the discharge from each nozzle. Fill the sprayer tank with clean water and position the equipment on a level surface. Be sure the water in the tank is at a level that can be duplicated when refilling. Operate the sprayer at the same rpm that would be used during an actual application.

Using your stopwatch, measure the time from when the valve is opened until it is closed again, usually from 1 to 3 minutes (Figure 2-11). Stop the equipment and measure the amount of water required to refill the tank to its original level. Repeat the same process two additional times and average the results.

If the tank has been calibrated



Figure 2-11. For high-pressure sprayers, spray liquid through the nozzles for a measured period of time, then measure the amount of water needed to refill the tank to its original level.

and marked, the amount of liquid used will be apparent or can be determined with a calibrated dipstick. Otherwise, use a flow meter attached to a low-pressure filling hose and refill the sprayer to the original level. Record the gallons of water used; this volume is the amount of liquid sprayed during the timed run. Repeat this process two more times to get an average of sprayer output.

Spray Check Devices.

Spray check devices are calibration aids that provide a visual representation of the spray pattern produced by nozzles on spray booms. This portable device is placed under a boom of a low-pressure sprayer

and the output from several nozzles is collected into a series of evenly spaced cells. After collection, the device is rotated from a horizontal to a vertical position; collected liquid drains into vials corresponding to the individual cells. Floats inside these vials rise to the top of the liquid level. Variation in levels can be readily seen, pinpointing nozzle problems and poor nozzle height adjustment.

Width of Spray Swath

(Supplies needed: tape measure, Calibration Information Sheet.)

The final measurement needed to complete calibration is the width of spray swath being applied

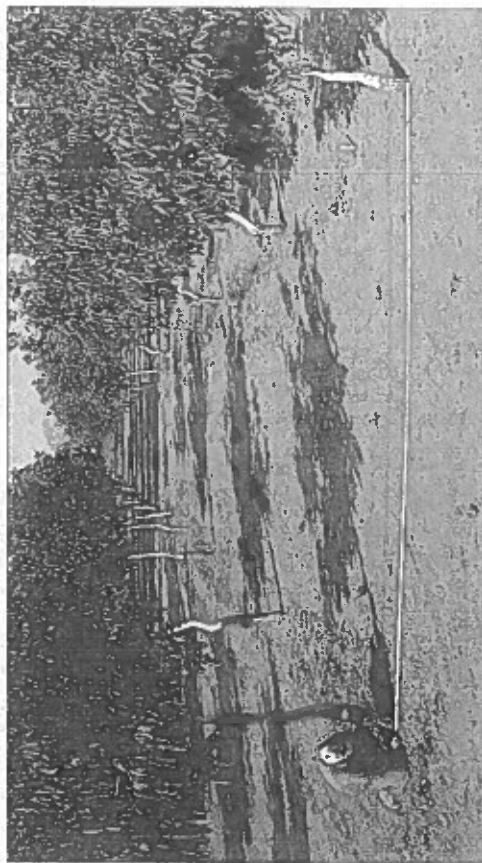

Figure 2-12. Measure the width of the swath to be sprayed. In orchards and vineyards, this is the tree or vine spacing.

by your sprayer. For multiple-nozzle, boom-type sprayers, calculate the swath width by multiplying the number of nozzles by the nozzle spacing. In orchards and vineyards, the swath width is the width of the planted rows (Figure 2-12).

Measure the swath width of a backpack or other small sprayer from the spray pattern produced on the ground in a test run. Keep the nozzle at the height held during an actual application, maintaining this height at all times to prevent variation in swath width. Refer to nozzle manufacturer catalogs for recommended spray heights for the nozzles you are using. Attach a small chain or weighted rope to the spray wand or boom and adjust its length to correspond to the desired height. This will provide an easy reference for maintaining the height of the nozzles.

Determining the Area to Be Treated

(Supplies needed: calculator, pesticide label, Calibration Information Sheet.)

You must accurately measure the area to be treated so you will know how much pesticide will be required. Accurately measure each

APPLY

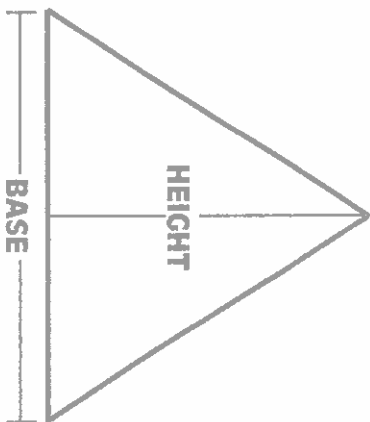

$$\text{Area} = \text{height} \times \frac{1}{2} \text{ base}$$

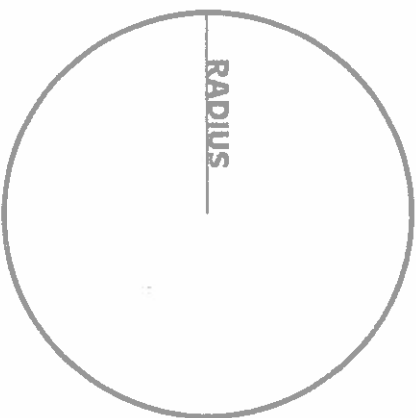

$$\text{Area} = \text{radius} \times \text{radius} \times 3.14$$

of your farm blocks or fields and keep this information on file.

If the area to be treated is relatively square or rectangular in shape, multiply the length by the width and divide the total by 43,560, which is the number of square feet in one acre. If the area is triangular or circular in shape, the methods are slightly more involved and these are described below.

For a triangular area, measure the height and the base of the triangle (see the drawing above). Multiply the height by one-half of the base, then divide that total by 43,560.

For a circular shaped area, measure the width (diameter) of the circle at its greatest expanse. Half of this number will equal the radius of the circle (see drawing at left). Multiply the radius by itself (radius times radius) and multiply that number by 3.14, which is the numerical equivalent of *pi*. Divide the total by 43,560.

For irregular shaped parcels, the best approach involves mapping the area onto graph paper. Once it is accurately drawn on the paper, break down the overall irregular shape into smaller square

or rectangular units, determining an area in square feet and acres for each smaller parcel. Once the size of each subsection is measured, add the smaller units together to determine an overall measurement.

Determining the Amount of Pesticide to Use

(Supplies needed: calculator, pesticide label, Calibration Information Sheet.)

Now that you have measured the tank volume, speed of application, flow rate, swath width, and the size of the target area, you will be able to calculate the amount of pesticide you will need for the entire job. You will then know how much to put into each tank load. In each case, no matter the shape of the area, once the acreage is determined, multiply that total by the recommended rate per acre on the pesticide label to determine the total amount of pesticide you will need to buy for the job. From the

Calibration Information Sheet calcu-

late the number of acres one tank load will cover. You have now determined the total amount of pesticide and the number of tank loads needed for the treatment area.

Be certain the amount of spray

applied per acre you have calculated corresponds to the **DIRECTIONS FOR USE** recommendations for gallons of diluted spray to be applied per acre. If your sprayer applies less than this minimum requirement, change the output by following instructions in the next section.

Changing Sprayer Output

Once a sprayer has been calibrated, its output rate is determined for a specific speed. There may be times when this output rate needs to be changed to accommodate for variations in the foliage, plant density, terrain differences, or other aspects of the treatment area, or to accommodate label requirements. Also, you will need to adjust the spray output as nozzles or pumps begin to wear. Several adjustments can be made, either alone or in combination, to effectively increase or decrease sprayer output within a limited range.

Changing Speed. The simplest way for you to alter the volume of spray being applied to an area is to change the travel speed of your sprayer. A slower speed results in more liquid being applied, while a faster speed reduces the application

rate. Operating application equipment too fast is a common error and will result in poor coverage. Operating it too slow results in waste, possible over application, and an increase in application time and cost.

If you change the speed of application, you also will need to change the amount of pesticide you put into the spray tank. For example, if you slow the travel speed, be sure to reduce the amount of pesticide put into the tank. Otherwise too much pesticide will be applied per acre.

Changing Output Pressure. As nozzles begin to wear, the spray volume increases. When a pump becomes worn, it becomes less efficient and therefore the nozzle out-

put drops off. Adjusting the pressure regulator to increase or decrease output pressure changes the spray volume slightly (Figure 2-13). Increasing pressure causes more output, while decreasing pressure lowers output.

Changing pressure has its limitations, however. In order to double the output volume, you must increase the pressure by a factor of four. This usually is beyond the capabilities of the spraying system, because the amount of adjustment that can be achieved is limited by the working pressure range of the sprayer pump. Whenever pressure in the system is changed, you need to remeasure the nozzle output and rework the calibration calculations.

Manipulating the operating pressure also has its hazards. The potential for drift increases as operating pressure is increased because finer droplets are formed at higher pressures. Also, changing pressure too much reduces the effectiveness of nozzles by altering the spray pattern.

Changing Nozzle Size. The most effective way for you to change the output volume of your sprayer is to change the nozzle size. Larger nozzles increase volume,

while smaller ones reduce volume. Using smaller nozzles can increase drift potential, however. California regulations limit nozzle orifice size to not less than $\frac{1}{16}$ inch when applying phenoxy herbicides. Changing nozzles usually alters the pressure of the system and requires you to adjust the pressure regulator.

The volume output of disc-core nozzles may be adjusted by changing either the disc or the core, or by replacing both. Be aware that changes in either the core or disc will also change the droplet size and spray pattern. Use tables included in nozzle manufacturers' catalogs as a guide for estimating output of different combinations. Whenever any nozzles are changed, recalibrate the sprayer and refigure its new total output.

Calibrating Granular Applicators

The techniques for calibrating your granular application equipment are similar in many ways to those used for liquids. However, your granular applicator must be calibrated for each type of granular pesticide you apply and for each

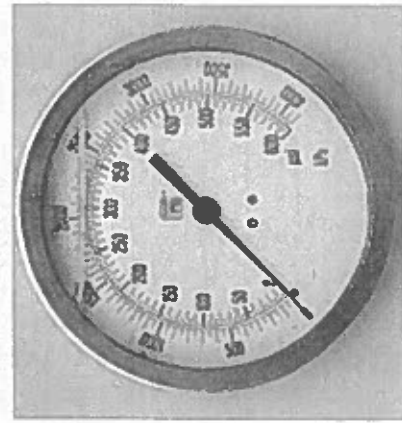
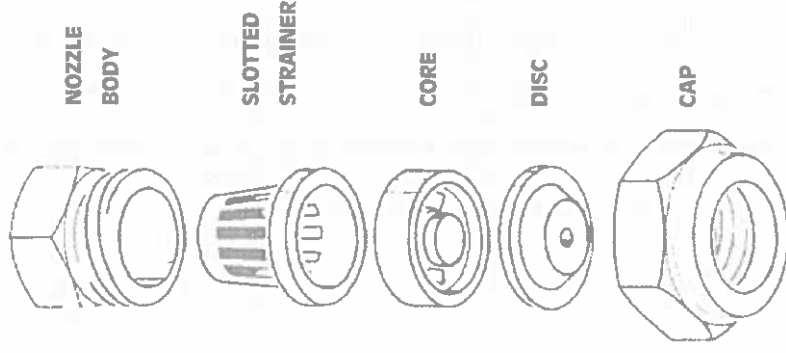

Figure 2-13. Slight changes in pressure can alter the output of your sprayer to accommodate for nozzle wear.

change in weather or terrain conditions. Granules may vary in size and shape from one pesticide to the next, influencing their flow rate from the equipment hopper. Temperature and humidity, as well as characteristics of the site, also influence granule flow.

Before you begin to calibrate your granular application equipment, be sure the equipment is clean and all parts are working properly. Be sure that it has been lubricated. Calibrating your granular applicator will involve using actual pesticide—unless special blank granules are available—so be very careful. Always wear rubber gloves to prevent contact with residues on the equipment. Protect other parts of your body with personal protective equipment to prevent skin exposure. Some formulations are dusty, and therefore you may need to wear required respiratory protection. “Belly grinders,” while simple to use, have the greatest potential for applicator exposure from dust.

Three factors need to be measured when calibrating your granular application device: travel speed,

rate of output, and swath width.

Travel Speed

(Tools and supplies needed: 100-foot tape measure, stopwatch, Calibration Information Sheet, calculator.)

Determine travel speed in the same manner as you would for liquid applications, following the instructions given above. Applicator hoppers should be half-full so the speed can be measured using an average load under actual operating conditions.

Rate of Output

(Tools and supplies needed: plastic or canvas tarp of known size, 1-gallon container, scale, Calibration Information Sheet, calculator.)

Completely fill the hopper or hoppers with the granular formulation you plan to use. Your equipment will probably have ports with adjustable openings for granules to pass through. Refer to charts supplied by the manufacturer to determine the approximate opening for the rate and speed you will be using. Once the approximate opening is set, use one of the following three methods to determine the actual output rate.

Measure the Quantity of Granules Applied. Collecting and weighing the granules actually applied to a known area is often the easiest way for you to calibrate your granular applicator and should be used when working with small “belly grinder” equipment. Spread out on the ground a plastic tarp of known size. Operate the applicator across this tarp at the actual application speed. Place the granules collected by the tarp into a container and weigh them. Record this weight on the *Calibration Information Sheet*. Using the *Calibration Information Sheet*, calculate the application rate for your granular applicator.

Collect a Measured Amount of Granules. Collecting and weighing quantities of granules over a known period of time is similar to calibrating a liquid boom sprayer with multiple nozzles; use this or the fol-

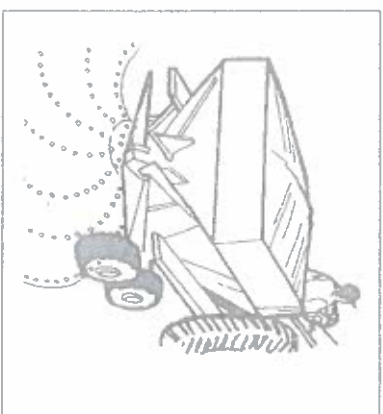

lowing method if your granular applicator has multiple ports. While operating the applicator at a normal speed, collect granules from each port into a container; record the time required to collect each sample. Weigh samples separately, and then add the weights together. Using the *Calibration Information Sheet*, calculate the application rate for your granular applicator.

Refill the Hopper. This method may be used with hand-operated equipment or when small quantities are being applied, but is most useful for aerial applicators or when multiple applicators are used together on a boom. Fill the hopper or hoppers to a known level and operate the equipment for a measured period of time. When finished, weigh the quantity of granules required to

refill the hoppers to their original level. Using the *Calibration Information Sheet*, calculate the application rate for your granular applicator. Measure the swath width at the same time using the instructions that follow.

Measuring Swath Width

(Tools and supplies needed: containers for collecting granules, scale, Calibration Information Sheet.)

To measure the swath width of granules dispersed by your equipment, operate the equipment under actual conditions. Whenever possible, place cans, trays, or other containers at even intervals across the width of the application swath to collect granules. Measure the swath width and weigh the granules collected in each container separately to determine the distribution pattern. Some spreaders can be operated over a strip of black cloth or plastic to provide a rapid visual assessment of granule distribution and swath width.

Determining Application Rate

(Supplies needed: calculator, pesticide label, Calibration Information Sheet.)

From the output rate of your applicator you can determine the rate of pesticide being applied per acre. Then, complete the calculations for your own granular applicator, using the *Calibration Information Sheet*. Check the pesticide label for the recommended rate. If your calculations do not correspond to the label rate, adjust the equipment and repeat the calibration procedure.

Motorized and hand-operated applicators apply granules at a fixed output, independent of ground speed. If ground speed increases, the effect will be to reduce the amount of granules applied per acre; conversely, when ground speed decreases, more material is applied. When using this type of equipment, the application rate can be adjusted not only by the size of the port opening, but also by the speed of travel.

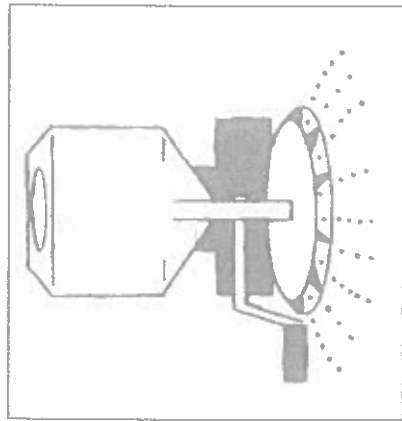

21. Increasing sprayer pressure will:
- Increase drift because droplets will be larger
 - Increase drift because droplets will be smaller
 - Decrease drift because droplets will be smaller
 - Decrease drift because droplets will be larger
22. Frequent calibration of your application equipment will assure that you:
- Are using the correct amount of pesticide for effective pest control
 - Always use the maximum amount of pesticide allowed by law
 - Will never have pest problems
 - Can make effective pesticide applications during severe weather conditions
23. Which of the following could be a result of *proper* equipment calibration?
- Better spray coverage during high winds
 - Unnecessary loss of time and money
 - Inadequate pest control
 - Effective pest control
24. Why must you accurately measure the capacity of your spray tank?
- Tank manufacturer capacity ratings may be inaccurate
 - To be able legally to use more pesticide product per acre than prescribed by the pesticide label
 - Accurate measurement of the tank capacity is unnecessary for proper calibration
 - To comply with federal laws
25. When making a pesticide application, increasing travel speed of the spraying equipment will:
- Increase the amount of pesticide applied per acre
 - Decrease the amount of pesticide applied per acre
 - Have no effect on the amount of pesticide applied per acre
 - Improve coverage of the pesticide being sprayed
26. If sprayer output is not changed, you will need to _____ travel speed of the application equipment to maintain the same rate per acre when the swath width narrows from 20 to 15 feet.
- Decrease
 - Increase
 - Maintain the same
 - Triple

Chapter 3 RECOGNIZING AND AVOIDING PESTICIDE HAZARDS

Several types of potential hazards are associated with pesticide use on your farm. If you are personally exposed to some types of pesticides you could suffer short-term or long-term health problems (Figure 3-1). If you are careless and allow residues to drift or otherwise get into the environment, nearby workers, residents, or passersby may be injured. Environmental contamination by pesticides may lead to loss of water quality or injury to nontarget vegetation, honey bees, birds, or other wildlife. Through improper application, the pesticides you use may have *phytotoxic*—that is, injurious to plants—effects on your crops and cause you economic loss. Improperly applied pesticides also may cause damage to treated surfaces or, through drift, surfaces near the treatment area. In addition, indiscriminate or over-use of pesticides may result in pest resistance to certain compounds or disruption of

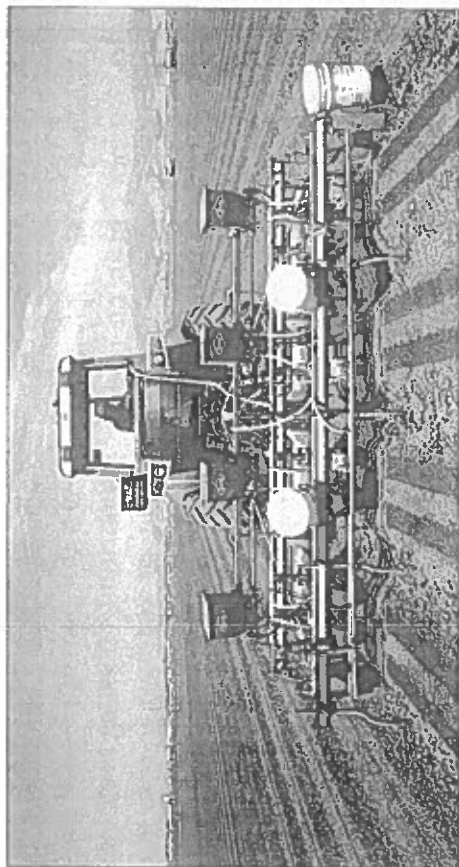

Figure 3-1. Although pesticides in the environment are hazardous, the most common problem with using pesticides is exposure to people during mixing or application activities.

biological control through destruction of natural enemies. Correct mixing, loading, and application techniques are only part of your responsibilities when using pesticides. You need to understand how pesticides can injure others or cause environmental contamination. Then you must take all the necessary precautions to keep this from happening. Responsible use of pesticides means protecting people as well as the air, land, surface water, groundwater, and plants and animals in your surroundings.

This chapter will refresh your understanding of the human health impacts and environmental considerations which must be part of each of your pesticide handling and application activities. Throughout the chapter is information you can use to avoid pesti-

cide-related hazards. The following chapter then discusses what to do to protect people and the environment should an emergency situation arise.

PESTICIDE RESIDUES

Whenever you apply pesticides, residues remain on treated surfaces for a period of time.

Residue levels are influenced by the chemistry of the active ingredient of the pesticide, the type of formulation, frequency of application and amount of pesticide used, and interaction with the environment. Residues are important and necessary in some types of pest control because they provide continuous exposure to the pest, improving chances of control. However, residues are undesirable when they expose people, domestic animals, and wildlife to hazardous levels of pesticides.

After an application, pesticide residues can remain in your soil, water, or on surfaces of nontarget areas. You can avoid hazardous pesticide residues if you:

- follow label instructions for timing, placement, and rate of application;

- apply pesticides during dormant or fallow periods, whenever possible, to prevent spraying edible produce;

- avoid pesticide spills;

- fill application equipment in ways that prevent pesticide mixtures from siphoning back into wells or overflowing onto the ground;

- calibrate application equipment properly and make an accurate measurement of the area to be sprayed to prevent mixing too much material;

- select pesticides that break down rapidly and use formulations that reduce problems of drift; and

- use cultural practices, such as soil and water conservation, to reduce pesticide movement.

HOW PEOPLE ARE EXPOSED TO PESTICIDES

There are several ways people come in contact with pesticides. The greatest risk of exposure occurs during mixing and applica-

tion and when entering or working in treated areas soon after application. Following the pesticide label instructions, wearing proper protective clothing, practicing good hygiene, and using other protective measures will reduce these types of exposures. To protect workers and consumers, adhere to label and regulatory guidelines for restricted-entry and harvest intervals.

As you work with pesticides, accidental spills may result in serious exposure. Protective clothing and prompt emergency response reduce the chances of serious injury if you or an employee have an accident (see the following chapter for more information).

It is also possible for people to be exposed to small amounts of

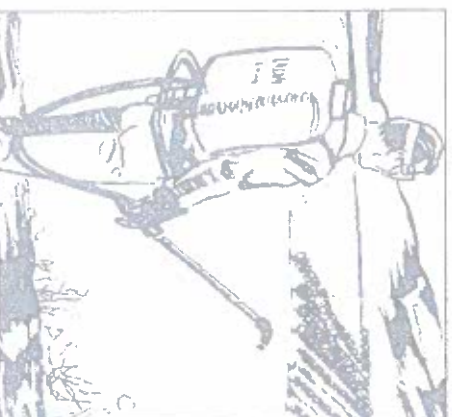

pesticide if they live near areas where you are spraying. Anyone who eats treated produce from your fields before the harvest interval expires will risk exposure. People will also risk exposure if they touch recently treated plant foliage.

One of the most tragic types of pesticide injury is caused by storing pesticides in food or drink containers (Figure 3-2). Many cases have been reported of children drinking pesticides from soft drink containers. Never store pesticides in anything other than the containers in which they were purchased. Don't take farm chemicals home to use around the house. Unless you or a responsible



Figure 3-2. Never store pesticides in food or drink containers, and always keep pesticides and empty containers in locked areas.

employee has control over the containers, keep pesticides locked up in a storage area that is inaccessible to children or untrained adults.

Poisoning or injury sometimes results from a single exposure to a large quantity of pesticide. In other cases, injury will not occur until you have been exposed repeatedly over a period of time. It is quite common for individuals to vary in their sensitivity to the level of pesticide exposure. Some people may show no reaction to a dose that causes severe illness in others. Your age and body size often influence your response to a given dose. Thus infants and young children are normally affected by smaller doses than adults. Also, adult females more often are affected by lower doses than adult males.

Effects of Exposure

The type and severity of injury or poisoning depend on the toxicity and mode of action of the pesticide you are using, the amount absorbed into your body, how fast it is absorbed, and how fast your body is able to break it down and excrete it.

You can lessen the severity of pesticide-related injury through

prompt first aid and medical treatment. Depending on the toxicity of the pesticide, larger doses may cause severe illness. Effects of exposure may be localized—such as irritation of your eyes, skin, or throat, or generalized—when pesticides are absorbed through your skin, membranes, or intestines and carried to your internal organs. Certain pesticides may affect several different internal systems at the same time. The extent of involvement and damage is related to the characteristics of the pesticide and the dose.

Symptoms. Symptoms are any abnormal conditions that you see or feel or that can be detected by examination or laboratory tests. These symptoms indicate the presence of an injury, disease, or disorder.

When you have been exposed to a large enough dose of pesticide to produce injury or poisoning, you may experience either an immediate or delayed appearance of symptoms. Immediate symptoms are those observed soon after exposure—known as *acute onset*. Sometimes symptoms from pesticide exposure may not show up for weeks, months, or even years. These delayed, or *chronic onset*, symptoms may either come on gradually or

Be sure to train pesticide handlers and fieldworkers to recognize pesticide poisoning symptoms. See training instructions and sample forms on appendix pages 98–101.

appear suddenly; they may be difficult to associate with their cause because of the lapse of time between exposure and observable effect.

Poisoning symptoms vary among classes of pesticides and pesticides within a class. The presence and severity of symptoms usually is proportional to the amount of pesticide (dosage) entering your tissues. Common symptoms include a skin rash, headache, or irritation of your eyes, nose, and throat. These types of symptoms may go away within a short period of time and sometimes are difficult to distinguish from allergy symptoms, a cold, or the flu. Other symptoms, which might be due to higher levels of pesticide exposure, include blurred vision, dizziness, heavy sweating, weakness, nausea, stomach pain, vomiting, diarrhea, extreme thirst, and blistered skin. Poisoning may also result in apprehension, restlessness, anxiety, unusual behavior, shaking, convulsions, or unconsciousness. Although these symptoms can indicate pesticide poisoning, they also may be signs of other physical disorders or diseases. Usually diagnosis requires careful medical examination, laboratory tests, and observation.

Types of injuries. You or your workers and others can be injured either by a single massive dose being absorbed during one pesticide exposure, or from smaller doses absorbed during repeated exposures over an extended period of time. The illness may be acute—having a sudden onset and lasting for a short duration, or it may become chronic—persisting for a long time. Injuries caused by pesticides usually are reversible; that is, they can either be repaired by the body's natural processes or through some form of medical treatment. Accidental exposure to some pesticides, however, may cause irreversible or permanent damage, which can result in a chronic illness, disability, or death.



Ways to Prevent Exposure

People who handle pesticides or contaminated equipment are best protected if they are properly

trained to avoid hazards and if they use appropriate personal protective equipment (PPE) and practice good personal hygiene. People who work in areas where pesticides have been applied can reduce exposure by being aware of the hazards, observing restricted-entry intervals, wearing appropriate clothing, and practicing good hygiene.

If you follow the calibration and application recommendations outlined in the previous chapter, you can avoid much of the offsite movement of pesticides. This will protect people working in nearby fields, residents living in the area, and passersby.

Pesticide Handler Training. California regulations require that all pesticide handlers receive yearly training from their employers. This training must be specific to the types of pesticides they handle. Employers must document the training and the training record must be signed by the employee. Training must be updated before each new class of pesticide is handled. Employers are required to maintain the records of training along with the training plan and training resources for a period of two

years. See page 98 in the Appendix for training requirements and an example of the training record that can be used by employers.

Heat Related Illness. California regulations require that pesticide handlers receive training on recognizing, avoiding, and treating heat related illness. This is to protect pesticide handlers who may be required to wear personal protective clothing. Additional regulations limit the use of pesticides that require handlers to wear waterproof or chemical resistant body coverings. If waterproof or chemical resistant protective clothing is prescribed on the label, the pesticide can only be applied during daytime hours when the air temperature is below 80°F or nighttime hours when the air temperature is below

85°F. Air conditioned cabs or some type of personal body cooling system can be used by pesticide handlers to avoid these restrictions.

Heat-related illness may mimic certain types of pesticide poisoning. Symptoms of heat illness include tiredness, weakness, headache, sweating, nausea, dizziness, and fainting. Preventing heat illness includes drinking plenty of water (at least a cup of water every half hour) and taking frequent breaks in the shade to cool down. Personal protective clothing that is worn during pesticide handling activities should be removed or loosened during breaks.

Severe heat illness can cause a person to act confused, get angry easily, or behave strangely. Without prompt first aid, the person could die. If you suspect that someone has severe heat illness, it is very important to cool the person down as quickly as possible and then get the person to a doctor immediately. To cool a person down, take off their outer clothing, pour water on them, fan them vigorously, and wrap them loosely in wet cloths or towels. Keep pouring water on and fanning the person while transporting to a medical facility.

Fieldworker Training. California regulations require training for all employees who enter treated areas within 30 days from the expiration of a restricted-entry interval.

If you are unable to verify that an employee received this training within the past 5 years, you must provide it. In addition, you must notify your employees of any planned pesticide applications if they are working within $\frac{1}{4}$ mile of the application site, on property you control.

You must also make available to workers recent pesticide application information for your property. Workers must be able to readily see and read it without having to make a specific request. See pages 99-100 in the Appendix for a summary of the fieldworker training requirements.

Personal Hygiene. Bathing helps to remove pesticide residues from your skin and hair. Always shower after applying pesticides, carefully remove protective clothing to prevent body contact with residues, and then change into clean clothing (Figure 3-3). You and your workers should wash your hands with soap and water before eating, drinking, using the

See the information
on *Avoiding Heat
Related Illness*
on appendix pages
107-108.

For special
restricted-entry
intervals applicable
to some pesticides
used in California,
see appendix
page 102.

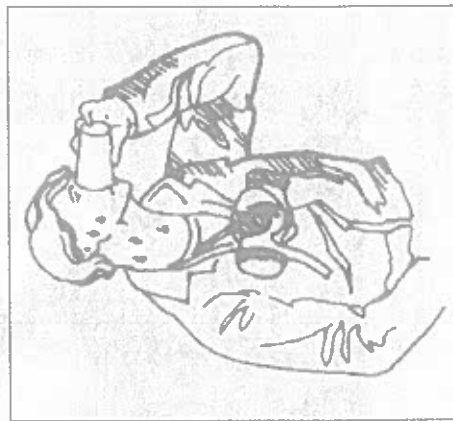

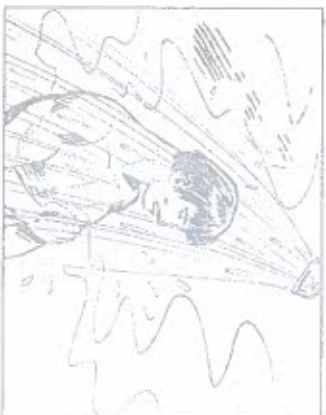

Figure 3-3. After mixing or applying pesticides or working on contaminated equipment, shower and change into clean clothing.

bathroom, and using tobacco products if you have been involved in handling pesticides or working in areas where pesticides were applied. You must provide workers who handle pesticides with a place where they can change clothes and wash at the end of the work shift. Be sure there are clean towels, soap, and water for thorough washing. You must also provide a clean, pesticide-free place where workers can store their personal clothing while handling pesticides. Be sure to instruct workers handling pesticides to bathe thoroughly as soon as possible after work.

Cleaning and Maintaining Your Protective Equipment. Your personal protective equipment is effective only as long as it is free

from pesticide contamination and works properly. Cleaning and inspection of this PPE are necessary steps in post-application cleanup. You should immediately replace or repair any defective or worn equipment.

Employers are responsible for providing clean protective outer clothing at the beginning of each work period to employees who handle pesticides with the signal words *Danger* or *Warning*. In addition, employers are responsible for providing (and assuring it is worn) all required personal protective equipment to employees who handle any pesticide. This equipment must be clean and in good repair at the beginning of each work period.

Inspect cartridge respirators carefully before cleaning them at the end of each workday. Respirator parts include the face piece, head bands or straps, filters, filter holders, gaskets, and valve flaps. When replacing worn or damaged parts, use only approved replacement parts for that specific brand and model. Replace filters according to manufacturer's instructions, or in the absence of instructions, at the end of each workday.

Clean the respirator after

removing filters and cartridges. First soak the respirator, gaskets, and valve parts in a solution of warm water and mild liquid detergent. Use germicidal cleaners (if labeled for this use) if the same respirator will be worn by more than one person. Use a soft brush or cloth to remove pesticide residues. Rinse the respirator and valve parts in clean water. Air dry rather than using applied heat. After it is completely dry, reassemble the respirator and store it in a clean plastic bag to protect it from dirt and environmental deterioration.

Wash rubber boots and gloves,



Figure 3-4. It is preferable to rinse your boots at the application site before removing them.

preferably at the application site, before taking them off (Figure 3-4). Use a detergent solution and soft brush for washing, then rinse with clean water. Do not wet the insides of boots. Be sure to wash the outside and inside of rubber gloves again after removing them. Fill each glove with water to check for leaks. Turn gloves inside out for drying.

When cleaning face shields, goggles, and safety glasses, take care to prevent scratching the lenses. Submerge them in warm, soapy water. If necessary, remove pesticide residue with a soft wet cloth or soft brush. Lenses treated with anti-fogging materials should not be rubbed, since this reduces their effectiveness. Rinse these items well with clear water and air dry or blot with a soft cotton cloth.

Wash protective clothing and coveralls at the end of each work shift to prevent possible exposure to residues by others. Discard clothing that has been saturated by a pesticide spill; do not launder these contaminated materials. If clothing and overalls will not be laundered immediately, store them in a plastic bag or other sealable container. Do not combine contaminated clothing with any other laundry before,

during, or after washing. Wear gloves to prevent skin contact with contaminated articles.

To clean the protective clothing you used for a pesticide application, first soak it in hot soapy water for at least ½ hour. Using pre-wash products improves pesticide removal. Launder this clothing in a standard washing machine using hot water and preferably a liquid laundry detergent (Figure 3-5). Set the washing machine at its longest cycle and use the highest water level. To prepare your washing machine for regular household laundry again, fill it to its highest level with hot water, add liquid detergent, and run it through its longest cycle without any clothing in it.

Whenever possible, hang washed protective clothing outdoors for drying, since the ultraviolet spectrum of sunlight breaks down many pesticides and air drying avoids contaminating your clothes dryer.

Clean waterproof protective clothing, such as rain suits and aprons, by first washing them with a hose and scrub brush outdoors in an area where runoff will not cause contamination (preferably the application site). Do this before

removing the garments if possible. Store these items in a clean plastic bag until they can be laundered. To launder, follow the procedures as described above. Do not place waterproof garments in your clothes dryer, as the heat will damage the waterproofing material. If the items are being hung in direct sunlight, turn them inside out to prevent deterioration of the waterproofing material by the sun and to help deactivate any pesticide residues



Figure 3-5. Clean protective clothing in a washing machine. Follow the washing instructions described in this section. Do not combine clothing used for pesticide handling with other laundry.

remaining on the inside surfaces.

Store personal protective equipment in a clean, dry place that is protected from temperature extremes and bright light. If possible, store the items in sealable plastic bags. Light, heat, dirt, and air pollutants all contribute to the deterioration of rubber, plastic, and synthetic rubber products. Never store protective clothing or equipment in areas where pesticides are kept.

Instruct employees who work in areas where pesticides have been applied to bathe thoroughly, preferably with a hot shower, at the end of each workday and change into clean clothing. They can lower their chances of pesticide exposure by washing their work clothing before reusing it.

HOW ENVIRONMENTAL CONTAMINATION OCCURS

Environmental contamination from pesticides can occur in a number of ways (Figure 3-6). It may be the result of drift, when wind and air currents carry pesticides you are applying out of the target area. It can also result when

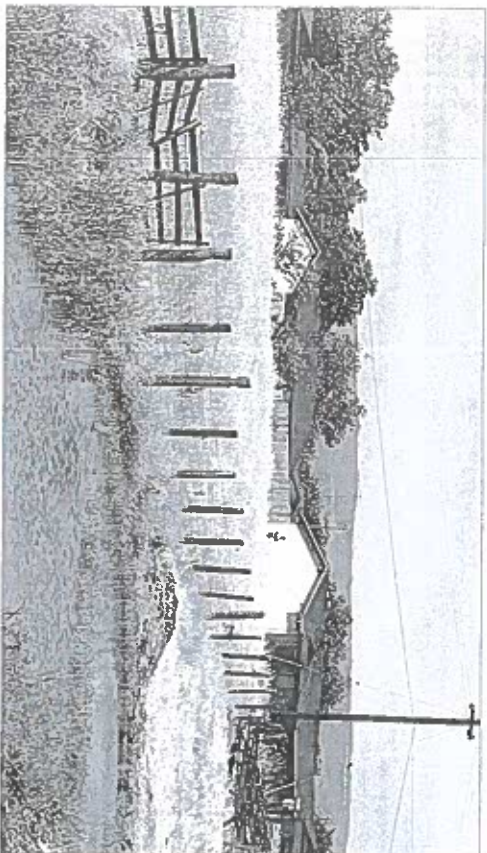

Figure 3-6. Pesticides you have applied can leave the target area through drift, runoff of irrigation water, and other ways.

pesticides you have applied leach or run off into surface water sources or groundwater.

Sometimes, environmental damage can occur even when the pesticides you have applied remain in the target area. For example, if nontarget species are in a field under treatment, or enter such a field soon after an application, they may be poisoned.

Some pesticides, especially the chlorinated hydrocarbons, are so persistent that they remain in the environment for many years after they have been applied. Therefore, areas that were previously used for

growing crops, and have since been converted into other uses, may still have residues of these pesticides.

Groundwater Contamination

Pesticide residues have been detected in many wells throughout California. In some cases the levels of pesticides found in these wells have been high enough to make the water unsafe for drinking. Since groundwater is California's most important freshwater source, hazardous levels of toxic chemicals in the groundwater are a serious

concern. Therefore, stringent laws have been put into effect to protect this resource. The ways you use pesticides and dispose of them are affected by these laws.

Factors Influencing Groundwater Contamination. The downward movement of pesticides through the soil is known as leaching. It is important for you to learn how to keep pesticides from leaching into the groundwater beneath your farming operation.

Pesticide leaching into groundwater generally occurs through either point or nonpoint pollution sources (Figure 3-7). Small amounts of pesticides entering the groundwater from normal applications over a large area are a form of *nonpoint pollution*. When larger amounts of pesticides leach through soil at small, defined locations, as in pesticide spill sites, disposal or storage sites, and mixing and loading areas, it is called *point pollution*.

How to Prevent Pesticide Contamination of Groundwater. To keep pesticides from entering the groundwater at your farming location, take the following precautions:

Storage. Store pesticides on an impermeable surface in enclosed areas protected from rain.

Mixing and Loading. Mix only the amount of pesticide needed for the job. Carefully mix and load pesticides in ways that avoid spills. Do not overfill your spray tank. Use check valves or air gap on filling pipes to prevent backflow of contaminated water into water supplies. Never leave your sprayer unattended while it is being filled with water.

Do not perform pesticide-handling activities (mixing, loading, storage, rinsing, application of preemergents) within 100 feet of water wells. Pesticide spills from mixing and loading activities, residues from cleaning equipment, and improper disposal of surplus pesticides in these areas can result in pesticide contaminants entering the groundwater around well casings.

If a spill occurs, clean up and dispose of the waste quickly and

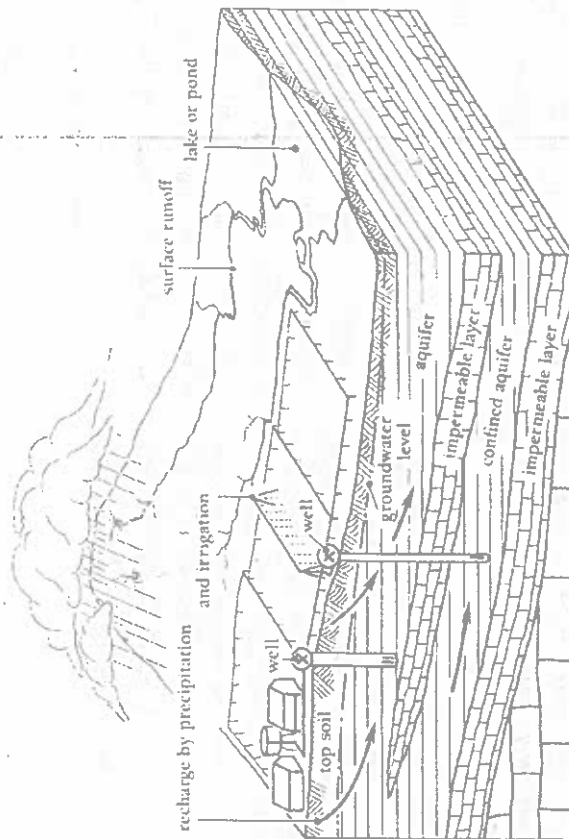

Figure 3-7. Point pollution sources are areas where large quantities of pesticide or other pollutants are discharged into the environment, such as from spills, waste discharge pipes, or dump sites. Nonpoint pollution sources are those arising from normal application where the pesticide or other material is applied over a large area.

Do not mix, load, store, rinse or apply pesticides within 100 feet of a well.

See the instructions for triple rinsing pesticide containers on appendix page 106.



Figure 3-8. Learn ways to reduce drift during a pesticide application.

safely in accordance with regulations. Follow cleanup guidelines on the material safety data sheet. You must remove contaminated soil and assure that it is transported to a class I landfill

When mixing pesticides, triple rinse empty liquid containers and pour the rinsate into the spray tank for application to the target site. Store rinsed containers in a locked area until they can be taken to a pesticide recycler or a designated disposal site.

Application. Reduce drift of pesticides off the target site by lower-

ing your equipment's spray pressure, using nozzles that produce large droplets, leaving buffer areas, and practicing other safe application techniques. Make applications during optimum weather conditions, whenever possible, to reduce offsite movement of pesticides through drift and runoff (Figure 3-8).

Disposal. Never dump pesticides or pesticide mixtures onto the soil or into sewers, drains, septic systems, or water sources. Store pesticide waste and unused product for eventual transport to approved disposal sites.

Surface Water Contamination

Surface waters such as irrigation canals, rivers, streams, and lakes are sensitive to pesticide contamination. Drift from nearby applications, as well as runoff from rain or irrigation, can carry pesticides into the surface waters. This creates a serious problem because of our dependence on surface water for irrigation, drinking, and human recreation. Effects on aquatic life and other animals can impact the entire ecosystem.

PESTICIDE IMPACT ON NONTARGET ORGANISMS

Nontarget organisms include all plants and animals other than the pest being controlled by a pesticide application. As much as 55% of an applied pesticide may leave the treatment area due to spray drift, volatilization, leaching, runoff, and soil erosion. Pesticides that drift or move onto adjacent areas may cause damage to crops, livestock, or wildlife, and may contaminate lakes, rivers, and streams. Some herbicides in concentrations as low as $\frac{1}{1000}$ of a pound

(0.454 gram) per acre may reduce yields. Under certain weather conditions, and if large acreage is being treated, pesticide concentrations in this range can drift out of the treatment area and move for *several miles* before settling to the ground.

Honey Bees. Certain types of insecticide and fungicide applications may kill honey bees. Honey bees are most susceptible if you apply harmful pesticides while they are foraging for nectar and pollen. The best way to protect honey bees from pesticides is to avoid applications when your crops or surrounding weeds are in bloom and bees are likely to be present. Apply sprays early in the morning, late in the afternoon, or during the night, when bees are not present.

Natural Enemies and Other Beneficial Species. Some beneficial species feed on or parasitize pest insects, mites, or weeds in your cropping system. These beneficial species are called natural enemies. Other beneficials help decompose dead plant and animal materials. Beneficial fungi and nematodes play important roles in decomposing dead plants and animals in your soil and contribute to the long-term natural control of pests on your farm.

Unfortunately, when you apply a pesticide, beneficials can be destroyed along with the target pest. Disrupting the natural control of pests by destroying their enemies often leads to your increased dependency on pesticides to do the job previously done by beneficials.

There are several ways you can reduce damage to beneficials on your farm. One way is to use pesticides that are the least toxic to beneficials. Also, make applications at times when natural enemies are least likely to be harmed, such as during dormant periods. Use the lowest rate that will control the target pest. Whenever possible, use spot treatments or other methods that minimize the amount of pesticides you need to apply. Refer to the *UC IPM Pest Management Guidelines* (see appendix for information on how to obtain the *Guidelines*) for pest management options that will help you protect beneficials.

Wildlife. Wildlife may be harmed by your pesticide applications either as a result of accidental poisoning or through alteration of their food sources and habitats (Figure 3-9). Vertebrates, includ-

ing birds, often feed or nest in areas where you apply pesticides. Sometimes these animals are the unintended victims of baits you may use to control certain pests. These species may also be poisoned when they feed on animals that were killed by pesticides you applied on your farm. Even if a pesticide exposure does not directly cause illness or death, it may weaken a nontarget animal and indirectly cause death by leaving the animal unable to get food and water or protect itself from predators. Some pesticides affect the ability of wildlife to reproduce.

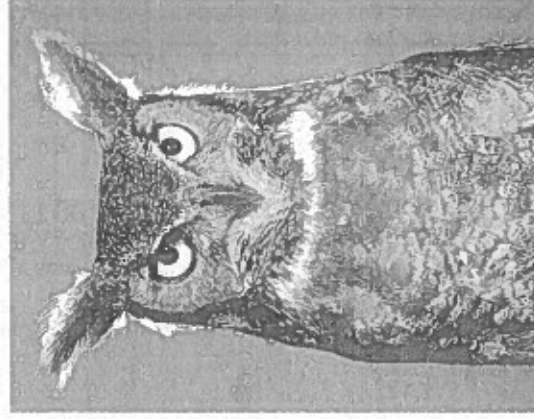

Figure 3-9. Wildlife may be affected by pesticides by direct poisoning or by destroying their food supply.

Fish are susceptible to many pesticides that get into waterways, even at low concentrations. Pesticides enter waterways through drift, by direct application, by leaching, or through runoff.

For advice on cleaning up pesticide spills and for other pesticide emergencies, contact CHEMTREC at 1-800-424-9300.

cides can prevent many accidents. If you should spill pesticides on public roads, they can be blown, splashed, or scattered by passing vehicles. Spilled chemicals may wash into ditches, streams, and

rivers during rainstorms, creating the potential for serious damage, including groundwater contamination. Spilled pesticides may also contaminate your vehicle and its cargo; it may be impossible to remove completely all residues from the vehicle.

If you have an accident involving spilled pesticides, call 9-1-1. Commercial applicators working on your property must report to the agricultural commissioner as soon as practicable if there is a forced landing, emergency, or accidental release of pesticide. Keep



Undiluted pesticides are a greater risk to people and the environment than are diluted spray mixtures. Your safe handling and transporting of undiluted pesti-

HANDLING PESTICIDE CONTAINERS

people and vehicles away. Stay at the scene of a spill until responsible help arrives. You or the responding emergency team can get advice on cleaning up spills from CHEMTREC at 1-800-424-9300.

See the following chapter for more information on cleaning up pesticide spills.

POSTAPPLICATION CLEANUP

Effects on human and environmental health are greatest when the exposure comes from undiluted pesticides. But diluted pesticides and their residues are also dangerous. There is a legal difference between hazardous materials, such as pesticides that will be applied, and hazardous wastes, such as leftover or unusable pesticide mixtures. You can avoid the prohibitive expenses of disposing of pesticide waste by following the procedures listed below:

Disposing of Leftover Pesticides. Even when your equipment is properly calibrated there may be pesticides left in your spray tank after completing an application. Before disposing of

this material, first try to apply it to a legal application site (one listed on the pesticide label). It may be necessary to dilute the mixture and spray it evenly over a previously treated area, if this can be done without exceeding the label rate. Leftover pesticides can also be stored in correctly labeled *service containers* for future use on legal sites. This is not always possible, as some pesticides lose their effectiveness over time, or the pesticide may not be needed again that season. The last resort is to have the pesticide shipped to a Class 1 disposal site. This may be your only legal remedy, and it can be expensive.

Don't ever dump leftover pesticides. This is a potential source of environmental and groundwater contamination and is an illegal practice. Anyone convicted of illegal disposal of hazardous waste is

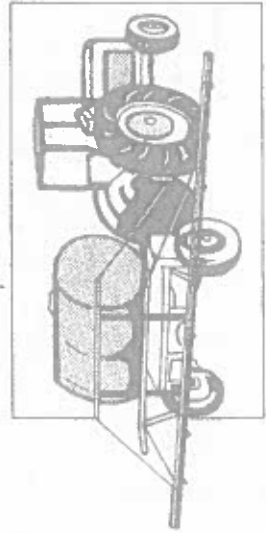

subject to a large fine and possibly a jail term.

Cleaning Contaminated Application Equipment. The residues that remain in or on your application equipment after pesticides have been applied can potentially cause human injury or environmental contamination. Therefore, you must clean and decontaminate your equipment immediately after finishing your application. Residues in the tank may contaminate your next pesticide mixture and possibly alter its toxicity. There is also the problem that some leftover residues may injure plants or cause other types of damage to sprayed surfaces.

People who clean or repair your contaminated application equipment are considered pesticide handlers because their activities put them in contact with contaminated surfaces. You need to provide the same training and personal protective equipment to these workers as you do for pesticide applicators. California regulations require eye protection and gloves be worn when repairing contaminated equipment.

Clean your equipment in areas where runoff will not drain into any waterway or other sensitive area, away from water wells, and where it will not leach into the groundwater. By cleaning your equipment at the application site, rinsate can be sprayed on that area. Wash the outside of the sprayer with water and a small amount of detergent if necessary. Fill the spray tank approximately one-third to one-half full with water and while running the agitator, flush the lines for several minutes. You can further decontaminate the tank by using commercial tank cleaning and neutralizing compounds. Follow label directions when using these materials.

When it is not possible to spray the rinsate onto an appropriate area, you must drain it into a labeled holding container and either: (1) use it as makeup water for filling your spray tank when using the same pesticide at a later date; (2) transport it to a hazardous materials (Class 1) disposal site; or (3) treat the rinsate in order to reduce the concentration of chemical in the water.

People who clean or repair contaminated pesticide application equipment are pesticide handlers. See appendix page 98 for training requirements and sample training form for these handlers.

REVIEW QUESTIONS

(answers found on page 88)

- Pesticide residues are *undesirable* if they:
 - Provide continuous exposure to the pest, improving chances of control
 - Break down rapidly
 - Do not move from the treatment site
 - Expose people, wildlife, and domestic animals to hazardous levels of pesticide
- To reduce the amount of harmful pesticide residues on treated surfaces, you can:
 - Use the highest legal rate of pesticide when making an application
 - Select pesticides that break down rapidly
 - Never make applications during a crop's dormant or fallow period
 - Use highly persistent pesticides
- When a person has been exposed to a pesticide through a spill, the chances of injury can be lessened if they:
 - Shower and change clothes after finishing work
 - Report the incident to their supervisor the following day
 - Remove the contaminated clothing and wash their skin immediately
 - Change clothes immediately after cleaning up the pesticide spill
- If a person develops a severe headache 15 minutes after a pesticide splashed onto them, this symptom is known as:
 - Chronic onset
 - Acute onset
 - Delayed onset
 - Slow onset
- People who work in areas where pesticides have been applied can protect themselves from unnecessary exposure by:
 - Reading books and pamphlets on avoiding pesticide exposure
 - Viewing videos about avoiding pesticide exposure
 - Talking to their friends about pesticide exposure
 - Wearing appropriate clothing and practicing good hygiene while at work
- How frequently must pesticide handlers be trained?
 - Every three months and before each new class of pesticide is handled
 - At least yearly and before each new class of pesticide is handled
 - Once every five years
 - Before each pesticide handling activity
- Which fieldworkers must receive pesticide awareness training?
 - All workers if pesticides have been used at any time during the current growing season
 - Workers who enter treated areas within 30 days from the expiration of a restricted-entry interval
 - All workers, even if no pesticides have been applied in the areas where they will be working
 - Only workers who enter areas before the expiration of the restricted-entry interval
- You are required to provide pesticide awareness training to employees who will be performing cultural practices in fields where a restricted-entry interval has been in effect during the past 30 days if:
 - You cannot verify that the employee received this training within the previous 5 years
 - You provided and documented training for these employees the previous year
 - The employees provide you with the blue EPA Worker Training Verification card
 - You plan to have these employees handle pesticides within the next month
- You are required to provide a place where pesticide handlers working for you can change clothes and wash at the end of the workday if these employees:
 - Mix or load pesticides for six or more days in any 30 day period
 - Handle pesticides for more than three hours during a single day
 - Live farther than five miles from their place of work
 - Perform any pesticide handling activities

10. You must provide clean work clothing at the beginning of each work period to employees who:
- Mix or load pesticides for six or more days in any 30 day period
 - Handle pesticides with the signal word CAUTION
 - Are unable to buy their own work clothing
 - Handle pesticides with the signal words DANGER or WARNING
11. The best place to wash off rubber boots after applying pesticides is at the:
- Pesticide mixing area
 - Application site
 - Farm shop or headquarters
 - Facility where handlers change their clothes
12. How often must personal protective equipment (PPE) be cleaned?
- After each day's use
 - Weekly
 - Monthly
 - After 8 hours of use
13. Personal protective equipment (PPE) should be stored:
- With pesticides in the pesticide storage area
 - With household clothing
 - In a clean, dry place away from areas where pesticide are kept
 - On the pesticide sprayer
14. Pesticides that leach through the soil can cause contamination to:
- Nearby crops
 - Groundwater
 - Birds and other wildlife
 - Personal protective equipment (PPE)
15. Nonpoint pollution is environmental pesticide contamination that occurs through:
- Normal application, where the pesticide is applied over a large area
 - A spill, where a large quantity of pesticide is discharged into the environment
 - Loading and cleaning pesticide sprayers in one small area for several years
 - A major fire involving a pesticide warehouse
16. The reason an air gap or check valves is required when filling a pesticide sprayer is to:
- Accurately measure the water being pumped into the spray tank
 - Prevent pesticide mixtures from backflowing into the water source
 - Avoid waste of pesticides
 - Prevent pesticide tanks from overflowing
17. Natural enemies are:
- Pests that attack crops and cause serious damage
 - Pests that attack crops and cause minor damage
 - Organisms that help to control pests
 - Pests that naturally occur in an area
18. If pesticides destroy natural enemies, the result may be:
- Greater dependence on more pesticides
 - Less crop damage
 - Cost savings
 - Fewer applications and less pesticides will be needed
19. Left over pesticides for which you have no use may be disposed of by:
- Sending them to the county landfill
 - Draining containers over a large area
 - Transporting to a Class 1 disposal site
 - Pouring into a storm drain
20. The best place to clean pesticide application equipment is:
- In an open area, away from people or wildlife
 - At the pesticide mixing area where water is available
 - Near a ditch, slough, or stream so rinsate will drain away
 - At the application site

Chapter 4

PESTICIDE EMERGENCIES



Figure 4-1. Any time you work around pesticides, you should be prepared to handle an emergency. Pesticide emergencies may be the result of leaks, spills, fires, thefts, misapplication, or improper storage or handling.

EMERG

Accidents may occur while you are handling or applying pesticides, even if you are working under the most careful conditions. Pesticides diluted with water may be hazardous, but undiluted pesticides are usually much more dangerous (Figure 4-1). Pesticide emergencies may be the result of leaks, spills, fires, thefts, misapplication, or lack of care in storage or handling.

Whenever you use pesticides, always have in your possession the names, locations and telephone numbers of nearby medical facilities capable of treating pesticide-related injuries. This information must be posted for your employees also. If an emergency situation arises and you have been exposed, seek medical care.

If others on your farm are exposed to pesticides, be prepared

to offer first aid if necessary. Ensure that they are taken for prompt medical attention. Post the notice shown on the following page (Figure 4-2) in a conspicuous place at the worksite or in the work vehicles.

FIRST AID

First aid is the help you are able to give a person exposed to pesticides before professional help can be obtained. However, first aid is not a substitute for professional medical care. The PRECAUTIONARY STATEMENTS section of pesticide labels provides specific first aid information.

Poisoning or exposure can occur if pesticides are splashed onto your skin or into your eyes, are accidentally swallowed, or if you inhale vapors, dusts, or fumes. The type of exposure determines what first aid and subsequent medical treatment is required. Serious pesticide poisoning can stop breathing or cause convulsions, paralysis, skin burns, or

blindness. Applying the proper first aid treatment for pesticide exposure may reduce the extent of injury and even save lives. You must decontaminate the exposed parts of your body as quickly as possible. To prepare yourself for such emergencies, enroll in an American Red Cross first aid course and cardiopulmonary resuscitation (CPR) training.

Protect yourself from contamination when administering first

aid to a person suffering from pesticide exposure. Avoid getting pesticides onto your skin, and do not inhale vapors. Do not enter a confined area to rescue a person overcome by toxic pesticide fumes unless you have the proper respiratory equipment. Remember, the pesticide that affected the injured person can also injure you.

Professional medical care must be obtained *at once* when anyone is exposed to pesticides or shows any

signs of pesticide poisoning; this requires transporting the injured person to a medical facility for treatment. Speed in obtaining medical care often controls the extent of injury. Provide medical personnel with information about the pesticide suspected of causing the injury and, if possible, bring the label.

PESTICIDES ON YOUR SKIN OR CLOTHING

Concentrated pesticides spilled on your skin or clothing can cause serious injury (Figure 4-3), either in the form of burns or rashes or through skin absorption resulting in possible internal poisoning. Immediately remove contaminated clothing and wash the affected areas with clean water and soap. Follow the sequence of first aid steps listed in the next section.

First Aid for Skin Exposure

Follow these steps in case you or someone else receives skin exposure to pesticides:

Leave the Contaminated Area.
Get away (or remove the victim) from the fumes, spilled pesticide,

ATTENTION EMPLOYEES EMERGENCY MEDICAL CARE

If you become ill or are injured on the job, you should be taken for medical attention to:

Medical Facility:
(name and address)

Telephone:

Ambulance: **Dial 9-1-1**

Report all injuries to your supervisor at once!

Figure 4-2. Post a notice, similar to the one shown here, in a conspicuous place at the worksite. Be sure all employees are shown where this notice is posted.



Figure 4-3. If pesticides spill on you, the first step is to remove contaminated clothing and wash the affected parts of your body with soap and plenty of water. Do this as quickly as possible to avoid serious injury.

and further contamination. Do this quickly! Do not become exposed to pesticides while doing this!

Restore Breathing. If the victim has stopped breathing, begin artificial respiration (rescue breathing) at once and continue until breathing resumes or until professional help arrives. If the person has stopped breathing and has no pulse, begin cardiopulmonary resuscitation (CPR) and continue until professional help arrives.

Prevent Further Exposure. Remove the contaminated cloth-

ing and thoroughly wash the affected skin and hair areas, using soap or detergent and large amounts of water.

Get Medical Attention. Call an ambulance or have someone provide transportation to the nearest medical facility as quickly as possible.

PESTICIDES IN YOUR EYES

Many pesticides can cause serious damage to your eyes. Prompt first aid, followed by medical care, helps reduce damage. Do not delay!

First Aid for Eye Exposure

To treat eye exposure, you must:

Wash the Eyes. Immediately wash the affected eyes with a gentle stream of clean, running water. Hold eyelids open to assure thorough washing. Continue flushing for at least 15 minutes.

When washing your eyes, do not use any chemicals or drugs in the wash water, since this may increase the extent of injury. Use a slow stream of running water and

wash your eyes for 15 minutes (Figure 4-4). Hold your eyelids open to assure the water reaches the affected eye tissues.

If running water is not available, slowly pour clean water from a glass, water cooler, or other container onto the bridge of your nose, rather than directly into your eyes.

Obtain Medical Care. Always get medical attention as soon as the flushing has been completed. Let medical providers know the name of the pesticide causing the injury.



INHALED PESTICIDES

Inhaled chemicals, such as fumigants, pesticide dusts, vapors from spilled pesticides, and fumes from burning pesticides, can cause serious lung injury and can be absorbed into other parts of the body through the lungs. Immediate first aid measures must be taken to reduce injury or prevent death.

Wear a supplied air respirator when entering an enclosed area to

rescue a person who has been overcome by pesticide fume. If you do not have a supplied air respirator, call for emergency help. Cartridge respirators are not suitable for high concentrations of pesticide vapors or deficient oxygen conditions. You can be of more assistance to the injured person by seeking proper emergency help than you can be if you are overcome by the pesticide yourself. Do not risk increasing the number of victims!

vapors trapped between clothing and the skin.

Restore Breathing. If breathing has stopped, or is irregular or labored, begin artificial respiration (rescue breathing). Continue assisting until breathing has improved or until medical help arrives. If the person has stopped breathing and has no pulse, begin cardiopulmonary resuscitation (CPR) and continue until help arrives.

Treat for Shock. Inhalation injury often causes a person to go into shock. Keep the injured person calm and lying down. Prevent chilling by wrapping the person in a blanket after removing contaminated clothing. Do not administer alcoholic beverages.

Watch for Convulsions. Protect the victim from falls or injury and keep air passages clear by making sure the head is tilted back.

Get Immediate Medical Care. Call 9-1-1 for an ambulance or transport the person to the nearest medical facility. Provide medical personnel with the name of the pesticide and the label, if possible.

First Aid for Pesticide Inhalation

Follow these steps in case you need to provide first aid to someone overcome by pesticide fumes: Call 9-1-1!

Leave the Contaminated Area/Remove an Exposed Person from the Contaminated Area. Anyone overcome by pesticide vapors must get to fresh air immediately and also must avoid physical exertion because this places an extra strain on the heart and lungs.

Loosen Clothing. Loosening clothing makes breathing easier and also releases any pesticide



Figure 4-4. If you get a pesticide into your eyes, wash them with clean running water for 15 minutes. Then, seek medical care.

POISON CONTROL SYSTEM

In a poisoning emergency, call 1-800-876-4766 (1-800-8-POISON) to connect to the poison control system in California.

SWALLOWED PESTICIDES

Two immediate dangers are associated with swallowed pesticides. The first is related to the toxicity of the pesticide and the poisoning effect it will have on a person's nervous system or other internal organs. The second involves physical injury that the swallowed pesticide causes to the linings of the mouth and throat and to the lungs. Corrosive materials, those which are strongly acid or alkaline, can seriously burn these sensitive tissues. Petroleum based pesticides can cause lung and respiratory system damage, especially during vomiting. Never induce vomiting if you suspect that the swallowed pesticide is corrosive or petroleum-based.

Regional poison information centers, located in Sacramento, San



Francisco, Fresno, and San Diego, can be reached by telephone 24 hours a day and 7 days a week. In a poisoning emergency, the Poison Control System can be reached throughout California by using a single toll-free number: 1-800-876-4766 (1-800-8-POISON). These centers provide quick, lifesaving information on poisoning treatment.

First Aid for Swallowed Pesticides

Act quickly when a pesticide has been swallowed. Follow these guidelines: Call 9-1-1!

Dilute the Swallowed Pesticide. If the person is conscious and alert, give large amounts (1 quart for an adult or a large glass for a child under 7) of water or milk. Do not give any liquids to an unconscious or convulsing person.

Induce Vomiting. If you are certain that neither a corrosive nor petroleum-based pesticide has been swallowed (check the pesticide label), induce vomiting. Make sure the person is kneeling or lying face down or on their right side. If in doubt, do not induce vomiting.

Obtain Medical Care. Call 9-1-1

for an ambulance or transport the poisoning victim to the nearest medical facility. Provide as much information as possible about the swallowed pesticide including the label, if possible.

PESTICIDE LEAKS AND SPILLS

All pesticide leaks or spills should be treated as emergencies. Concentrated pesticide spills are much more dangerous than pesticides diluted with water, but both types should be treated seriously and immediately. Leaks or spills can occur during transporting, storing, or while using pesticides. Pesticides may be spilled indoors, in enclosed areas, or outside.

When spills occur on public roadways, immediately call 9-1-1. When pesticides are spilled on public roadways, a report is required to be filed with the Office of Emergency Services. If leaks or spills should occur in areas other than public road ways, follow the emergency procedures listed below. All leaks or spills of pesticides being applied by custom (commercial) applicators, no matter where

they occur, must be reported to the agricultural commissioner as soon as possible.

Materials that have been cleaned up and anything that was contaminated by the spill must be placed into a sealed drum. Label the drum to indicate it contains hazardous waste. Include the name of the pesticide and the signal word (*Danger, Warning, or Caution*).

Because local regulations vary, contact the agricultural commissioner or Regional Water Quality Control Board for instructions on how to dispose of the sealed drum and its contents. Under most circumstances, the residue from a pesticide spill must be transported to a Class 1 disposal facility. Up to 10 pounds of soda ash can be added to the container before disposal to aid in pesticide detoxification. (Check the pesticide label and MSDS to make sure it is safe to use soda ash).

Spills on cleanable surfaces, such as concrete, require thorough decontamination. Commercial decontamination preparations are available for this purpose, or prepare a solution, using 4 tablespoons of detergent and 1 pound

of soda ash, dissolved in each gallon of water. (Soda ash cannot be used for detoxification of a few pesticides, so check the label or MSDS before using this solution. Contact the pesticide manufacturer if you have any questions.)

If anyone has been injured or contaminated, administer first aid. Send for medical help if necessary.

Barricade. Rope off the area or set up barricades to keep everyone away from the contaminated site.

Ventilate the Area. If the spill is indoors, get out of the building. Open doors and windows. Set up a portable fan.

Cleaning up Pesticide Leaks or Spills

Cleaning up major pesticide spills requires the help of professionals. It is extremely difficult and costly to remove contaminated soil or to prevent or clean up groundwater contamination. The types of pesticide leaks and spills you will most likely encounter will be controllable quantities when a container is damaged or slips to the ground or when diluted pesticide leaks from application equipment. Prop-

er and immediate response to even these types of small leaks and spills is necessary to minimize damage to human and environmental health.

There are certain basic steps you should follow in cleaning up a pesticide leak or spill:

Clear the Area. Keep people and animals away from the contaminated area. Provide first aid if anyone has been injured or contaminated. Send for medical help if necessary.

Some liquid pesticides are flammable, or are formulated in flammable carriers. Pesticide powders are potentially explosive, especially if a dust cloud is formed in an enclosed area. Do not allow any smoking near a spill. If the spill occurs in an enclosed area, shut off all electrical appliances and motors that could produce sparks and ignite a fire or explosion.

Wear Protective Clothing. Before beginning any cleanup, put on rubber boots, gloves, waterproof protective clothing, goggles, and respiratory equipment. Check the pesticide label for additional precautions, but when uncertain what has been spilled, wear the maximum protection.

Contain the Leak. Stop the leak by transferring the pesticide to another container or by patching the leaking container (paper bags and cardboard boxes can be patched with strong tape). Use soil, sand, sawdust, or absorbent clay to form a containment "dam" around liquid leaks. Common cat litter is a good absorbent material for pesticide clean up. If the wind is blowing pesticide dusts or powders, spray the pesticides with water or cover the area with a plastic tarp to prevent offsite movement.

Clean Up the Pesticide. Proceed to clean up the spill or leak. Brush the containment dam of absorbent material toward the center of a liquid spill. Add additional absorbent material if necessary. If the spill is on soil, shovel out contaminated soil for disposal. Place the absorbent or spilled dry product, and any contaminated soil, in a disposable container. Containers for holding contaminant materials must be sealable and suitable for transporting. The container must be labeled with contents, including pesticide name and signal word.

Clean Nonporous Surfaces and Safety Equipment. If the spill occurs on a cleanable surface, such

as concrete or asphalt, use a broom to scrub the contaminated surface with strong detergent solution. Again clean this up with absorbent material and place it in the container with the contaminated material. Equipment such as brooms, shovels, and dustpans must be cleaned or disposed of. When you finish, clean your personal protective equipment.

Dispose of the Material. Local regulations on disposal of hazardous materials may vary. Check with the agricultural commissioner or Regional Water Quality Control Board for instructions on how to dispose of the container and its contents.

PESTICIDE FIRES

Fighting pesticide fires requires special care because smoke and fumes generated by burning pesticides cannot be contained; areas endangered by these fumes must be evacuated. Toxic fumes hamper fire-fighting efforts and require the use of supplied air respirators and protective clothing. Water must be used with caution when fighting pesticide fires. Use it primarily to cool containers

and prevent overheated chemicals from exploding. Do not splash or spread toxic chemical with high-pressure water.

Once the fire has been brought under control, all hoses and equipment, including personal protective clothing, must be decontaminated. Residue remaining at the fire site must be removed and disposed of.

How to Deal with a Pesticide Fire

Follow this sequence when a pesticide fire breaks out:

Call the Fire Department.

Contact the nearest fire department as quickly as possible (call 9-1-1). Inform them that it is a fire involving pesticides. Provide them with the names of the chemicals contained in the structure or vehicle. If possible, provide Material Safety Data Sheets to the arriving fire units.

Clear the Area.

Get people out of the immediate area of the fire; there may be considerable risk of toxic fumes and explosion.

Evacuate and Isolate the Area Around and Downwind of the

Fire. Protect animals and move equipment and vehicles that could be damaged by the fire or fumes, or that would impair fire-fighting efforts. Keep spectators from being exposed to smoke from the fire and runoff from fire fighting. Contact the police or sheriff to evacuate downwind residences, schools, and buildings until the danger has passed.

MISAPPLICATION OF PESTICIDES

Another form of emergency may exist when pesticides have been misapplied.

Misapplication involves the use of a pesticide in a manner inconsistent with label directions, a common example being an application made to a site not allowed by the label or exceeding the label rate. Accidental misapplication involves unknowingly applying a pesticide to a site not on the label.

Negligent application involves improper calibration of application equipment as well as improper use and disposal of the pesticide; it also involves applying pesticides at the wrong time or in any other way inconsistent with label directions.

Making an application mistake is a serious problem; do not compound the damage by failing to take responsible, corrective action once the mistake is discovered. You may be financially responsible for damages, physical, medical, and legal, caused by the misapplication of a pesticide on your farm. The amount of damage and liability may be reduced by prompt action once the error has been discovered.

Of primary importance is the protection of people, animals, and the environment. Responsible, quick action also could help to offset penalties and legal claims.

Incorrect Amount of Pesticide Used

Insufficient quantities of pesticides usually do not give adequate control of the target pest and waste time and money, but generally present no immediate problems to people or the environment.

Excessive amounts of pesticide, however, can be an environmental threat as well as a danger to human health. This type of problem occurs as a result of poor calibration of your application equipment or is due to faulty mixing of chemicals in your spray tank. Residues from the pesticide may last longer than expected, or a concentrated application may cause damage to the treated area.

Correcting the Problem. Once an improper application has been discovered, take immediate action. Notify the agricultural commissioner of the problem and seek information and advice on what remedies can be taken. Contact the



pesticide manufacturer for help in determining what corrective measures can be taken. Remember, speed is of the utmost importance when trying to reduce damage.

Application of the Wrong Pesticide

Lack of attention to your mixing operation or giving the wrong instructions to an employee may result in the wrong pesticide being applied. Besides possible damage to plants or surfaces in the treatment area, using the wrong pesticide exposes you and your workers to unanticipated hazards. Mixing and application might take place unknowingly without using the

required personal protective equipment, resulting in possible injury to the applicator.

Correcting the Problem.

When you discover that you have mixed or applied the wrong pesticide, contact the agricultural commissioner for help and then call the pesticide manufacturer. Notify people in the application area and keep them away until it can be made safe again.

Pesticides Applied to the Wrong Site or Crop

Another form of accident involves pesticides being applied to the wrong site. This can be a serious problem if the site (or crop) is not listed on the pesticide label or if there are workers at the site who are performing cultural operations.

Correcting the Problem.

Contact the agricultural commissioner and the pesticide manufacturer for assistance. Keep people and animals out of the sprayed area until it has been determined that it is safe to return.



REVIEW QUESTIONS

(answers found on page 88)

1. The name, address, and location of a medical facility capable of treating pesticide-related injuries should be posted:
 - a. In a prominent file folder at your farm office
 - b. At the pesticide mixing site whenever pesticides are used
 - c. At the local county Agricultural Commissioner's office
 - d. At the pesticide dealer's facility
2. First aid and other emergency information for pesticide accidents is found:
 - a. In the front section of the local telephone directory
 - b. On the second page of the pesticide manufacturer's informational brochure
 - c. On the bottom of the pesticide container
 - d. In the precautionary statements section of the pesticide label
3. First aid for pesticide on the skin includes:
 - a. Removing contaminated clothing and washing with soap and water
 - b. Changing out of the contaminated clothing at the end of the work period
 - c. Lying down for 20 minutes, then removing contaminated clothing
 - d. Immediate transport to a medical facility for assistance in washing the affected areas of skin
4. If pesticide gets into your eyes, you should always:
 - a. Keep eyes shut tightly and covered with a damp cloth until irritation stops
 - b. Wipe eyes thoroughly with a clean cloth before returning to work
 - c. Flush eyes with clean water for 15 minutes before returning to work
 - d. Flush eyes with clean water for 15 minutes and seek medical attention
5. If pesticide vapors are inhaled, first aid procedures include:
 - a. Having victim breathe rapidly for 15 minutes
 - b. Send victim home for remainder of the work day
 - c. Loosen clothing, restore breathing if necessary, and seek medical care
 - d. Have victim drink a large quantity of alcoholic beverage
6. When someone swallows a pesticide you should:
 - a. Have victim stop work and rest for at least one hour
 - b. Get immediate medical care for victim
 - c. Have victim eat several pieces of fruit
 - d. Watch for signs of illness and seek medical care if symptoms appear and last for more than an hour
7. When cleaning up a spilled pesticide, the absorbent and all contaminated materials must be:
 - a. Buried at least 2 feet below the soil surface
 - b. Put into bags or containers and taken to the local dump site
 - c. Put into sealed containers and shipped to a Class 1 disposal site
 - d. Taken to the local Agricultural Commissioner's office for disposal
8. Information on cleaning up spilled pesticides can be found in the:
 - a. Front section of the local telephone book
 - b. Directions for use section of the pesticide label
 - c. Accidental release measures section of the material safety data sheet
 - d. Leaks and spills section of the pesticide manufacturer's brochure
9. Dealing with fires involving pesticides requires:
 - a. Large amounts of water to disperse the burning materials
 - b. Professional help, equipped and trained to fight pesticide fires
 - c. Seeking immediate help from neighbors and family members
 - d. Waiting until the burning has nearly stopped before calling the fire department
10. If the wrong pesticide has been applied to a site, you should:
 - a. Notify the county Agricultural Commissioner at once
 - b. Notify the Regional Water Quality Control Board at once
 - c. Call the Poison Control Center for advice
 - d. Watch for adverse effects and, if any appear, notify the county Agricultural Commissioner

ANSWERS TO REVIEW QUESTIONS

Chapter 1: The Pesticide Label

1. c
2. d
3. b
4. a
5. c
6. b
7. c
8. c
9. a
10. b
11. a
12. c
13. b
14. c
15. a
16. d
17. b
18. d
19. b
20. d
21. a
22. b
23. b
24. d

Chapter 2: Mixing and Applying Pesticides

1. a
2. b
3. a
4. c
5. d
6. c
7. b
8. c
9. d
10. a
11. c
12. d
13. b
14. a
15. c
16. a
17. c
18. b
19. c
20. d
21. b
22. a
23. d
24. a
25. b
26. b

Chapter 3: Recognizing and Avoiding Pesticide Hazards

1. d
2. b
3. c
4. b
5. d
6. b
7. b
8. a
9. d
10. d
11. b
12. a
13. c
14. b
15. a
16. b
17. c
18. a
19. c
20. d

Chapter 4: Pesticide Emergencies

1. b
2. d
3. a
4. d
5. c
6. b
7. c
8. c
9. b
10. a

APPENDIX

- Checklist for Planning a Pesticide Application – 90
- Pesticide Information Resources – 91
- Pesticide Poisoning Emergencies – 96
- Useful Resources for Pesticide Handling and Pest Management – 97
- Pesticide Handler Safety Training Record – 98 **SAMPLE FORM**
- Criteria for Fieldworker Training – 99
- Fieldworker Pesticide Safety Training Record – 100 **SAMPLE FORM**
- Training and Instructions for Early-Entry Workers – 101
- California Restricted-Entry Intervals – 102
- Organophosphate and N-Methyl Carbamate Pesticides – 103
- Production Agriculture Monthly Pesticide Use Report – 104
- Pesticide Safety Information Series – 105
- Procedures for Triple Rinsing Pesticide Containers – 106
- Avoiding Heat Related Illness – 107
- Useful Conversion Factors for Calibration – 109

Checklist for Planning a Pesticide Application

- **Personal:**
 - Medical checkup and necessary blood tests?
 - Pesticide handlers (mixers, loaders, applicators, people cleaning or repairing contaminated equipment, flaggers, people handling opened containers) properly trained for this type of pesticide?
 - Understand symptoms of exposure?
 - Understand first aid procedures in case of exposure?
- Application equipment properly calibrated?
- Emergency water and first aid supplies?
- Necessary supplies to contain spills or leaks (absorbent materials, cleaning supplies, holding containers)?
- **Transporting:**
 - Can transport pesticides safely to application site?
 - Pesticides and containers secured from theft or unauthorized access?
 - Vehicles properly marked and permits obtained, if necessary, for transporting hazardous materials and hazardous wastes?
- Livestock, pets, honey bees, other animals properly protected?
- Aspects of groundwater determined, if applicable?
- Hazards within treatment site identified, including electrical wires and outlets, ignition sources, obstacles, steep slopes, and other dangerous conditions?
- Plans in treatment area in proper condition for pesticide application (correct growth stage, not under moisture stress, other requirements as specified on pesticide label)?
- **Weather conditions:**
 - Weather is suitable for application (low wind, proper temperature, lack of fog or rainfall)?
- **Application:**
 - Application pattern established suitable for treatment area, hazards, and prevailing weather conditions?
 - Application rate selected which will give most uniform coverage?
 - Equipment frequently checked during application to assure that everything worked properly with uniform application?
 - Clean water, soap, single-use towels present at application site for emergency decontamination?
 - Provisions made for keeping people out of area during application?
- Disposable materials burned or disposed of in approved way?
- All handlers instructed to bathe and change clothing after handling activities?
- **Disposal:**
 - Paper pesticide containers burned or disposed of according to local regulations.
 - Plastic and metal containers properly stored until dispose of in suitable disposal area?
- **Storage:**
 - Unused pesticides returned to supplier or stored in locked facility for later use?
 - Storage facility is suitable for pesticides?
- **Reports:**
 - Monthly pesticide use report filed with county Agricultural Commissioner?
 - Other reports filed as needed?
 - Pesticide use records kept in accessible place for reference by workers and others?
- **Follow-Up:**
 - Treatment areas inspected after application to assure that pesticide controlled target pests without causing undue damage to nontarget organisms or surfaces of items in treatment area?
 - Assure that workers entering treated area for the 30-day period after expiration of the restricted-entry interval has received Worker Protection Standard training?
- **Equipment:**
 - Proper personal protective equipment (boots, gloves, respiratory equipment, protective clothing, eye protection, headwear)?
 - Personal protective equipment cleaned and inspected before use?
 - Understand how to avoid heat related illness?
 - Understand how to recognize and treat heat-related illness?
 - Necessary measuring and mixing equipment?
 - Suitable application equipment for this job (tank capacity, pressure range, volume of output, nozzle size, pump compatible with formulation type)?
- **Treatment site:**
 - Boundaries of treatment site inspected?
 - Environmentally sensitive areas within 1/2 mile of treatment area identified?
 - Notified people working or living in or near treatment area, including fieldworkers and their supervisors working on this property within 1/4 mile of the application?
 - Treatment site properly posted with required signs if necessary?
 - Soil types determined and noted, if these are factors in pesticide efficacy?
- **Clean-Up:**
 - Application equipment properly cleaned and decontaminated after application?
 - Personal protective equipment safely stored and then cleaned or laundered according to approved methods?
- **Damage:**
 - Damage, if it occurred, promptly reported?

Pesticide Information Resources

Federal and State Offices

U.S. Environmental Protection Agency—Region IX
75 Hawthorne Street
San Francisco, CA 94105-3901
(415) 744-1065

California Department of Pesticide Regulation
Pesticide Enforcement Branch
1001 I Street/P.O. Box 4015
Sacramento, CA 95812-4015
(916) 324-4100
<http://www.cdpr.ca.gov/docs/enfcmpli/enfmenu.htm>

California Department of Pesticide Regulation
Licensing Information
1001 I Street/P.O. Box 4015
Sacramento, CA 95812-4015
(916) 445-4038
<http://www.cdpr.ca.gov/docs/license/liccert.htm>

California Department of Pesticide Regulation
Worker Health and Safety Branch
1001 I Street/P.O. Box 4015
Sacramento, CA 95812-4015
(916) 445-4222
http://www.cdpr.ca.gov/docs/whs/whs_homepage.htm

Agricultural Commissioner and UC Cooperative Extension Offices

Agriculture Commissioner

Alameda County
224 W. Winton Avenue, Room 184
Hayward, CA 94544
(510) 670-5232
<http://www.co.alameda.ca.us/>

Alpine County

(see El Dorado/Alpine)
www.co.el-dorado.ca.us/ag/

Amador County

12200 Airport Road
Jackson, CA 95642-9527
(209) 223-6487
www.co.amador.ca.us

Cooperative Extension Office

1131 Harbor Bay Parkway, Suite 131
Alameda, CA 94502
(510) 567-6812
<http://cealameda.ucdavis.edu/>

12200-B Airport Road
Jackson, CA 95642-9527
(209) 223-6482
<http://ceamador.ucdavis.edu/>

Agriculture Commissioner

Butte County
316 Nelson Avenue
Oroville, CA 95965-3318
(530) 538-7381
www.buttecountry.net/agcommissioner

Calaveras County

891 Mountain Ranch Road
Government Center
San Andreas, CA 95249-9709
(209) 754-6504
www.co.calaveras.ca.us

Colusa County

100 Sunrise Blvd., Suite F
Colusa, CA 95932-3246
(530) 458-0580

Cooperative Extension Office

2279-B Del Oro Avenue
Oroville, CA 95965
(530) 538-7200
<http://cebutte.ucdavis.edu/>

Calaveras County

891 Mountain Ranch Road
Government Center
San Andreas, CA 95249-9709
(209) 754-6477
<http://cecalaveras.ucdavis.edu/>

100 Sunrise Blvd., Suite E/ P.O. Box 180
Colusa, CA 95932
(530) 458-0570
<http://cecolusa.ucdavis.edu/>

Agriculture Commissioner Cooperative Extension Office

Contra Costa County
 2366 "A" Stanwell Circle
 Concord, CA 94520-4804
 (925) 646-5250
www.co.contra-costa.ca.us/

75 Santa Barbara Road, 2nd Floor
 Pleasant Hill, CA 94523-4488
 (925) 646-6540
<http://cecontracosta.ucdavis.edu/>

Del Norte County
 2650 Washington Boulevard
 Crescent City, CA 95531-8627
 (707) 464-7325
www.co.del-norte.ca.us/

5630 S. Broadway
 Eureka, CA 95503
 (707) 445-7351
<http://cehumboldt.ucdavis.edu/>

El Dorado/Alpine Counties
 311 Fair Lane
 Placerville, CA 95667-4195
 (530) 621-5520
www.co.el-dorado.ca.us/ag/

311 Fair Lane
 Placerville, CA 95667
 (530) 621-5502
<http://ceeldorado.ucdavis.edu/>

Fresno County
 1730 South Maple Avenue
 Fresno, CA 93702-4596
 (559) 456-7510
www.co.fresno.ca.us

1720 South Maple Avenue
 Fresno, CA 93702
 (559) 456-7285
<http://cefresno.ucdavis.edu/>

Glenn County
 720 N. Colusa Street/ P.O. Box 351
 Willows, CA 95988
 (530) 934-6501
www.countyofglenn.net

831 E. South Street/P.O. Box 697
 Orland, CA 95963
 (530) 865-1107
<http://ceglenn.ucdavis.edu/>

Humboldt County
 5630 S. Broadway
 Eureka, CA 95503-6998
 (707) 445-7223
www.co.humboldt.ca.us

5630 S. Broadway
 Eureka, CA 95503-6998
 (707) 445-7351
<http://cehumboldt.ucdavis.edu/>

Imperial County
 150 South 9th Street
 El Centro, CA 92243-2850
 (760) 482-4314
www.imperialcounty.net

1050 East Holton Road
 Holtville, CA 92250-9615
 (760) 352-9474
<http://ceimperial.ucdavis.edu/>

Agriculture Commissioner Cooperative Extension Office

Inyo/Mono Counties
 County Services Building
 207 W. South Street
 Bishop, CA 93514-3492
 (760) 873-7860
www.countyofinyo.org

207 W. South Street
 Bishop, CA 93514
 (760) 873-7854
<http://ceinyo-mono.ucdavis.edu/>

Kern County
 1001 S. Mt. Vernon Avenue
 Bakersfield, CA 93307-2857
 (661) 868-6300
www.co.kern.ca.us/kermag/

1031 S. Mt. Vernon Avenue
 Bakersfield, CA 93307
 (661) 868-6200
<http://ceckern.ucdavis.edu/>

Kings County
 680 N. Campus Drive, Suite B
 Hanford, CA 93230-5923
 (559) 582-3211 ext. 2830
www.countyofkings.com

680 N. Campus Drive, Suite A
 Hanford, CA 93230
 (559) 582-3211 ext. 2730
<http://cekkings.ucdavis.edu/>

Lake County
 883 Lakeport Boulevard
 Lakeport, CA 95453
 (707) 263-0217
www.co.lake.ca.us

883 Lakeport Boulevard
 Lakeport, CA 95453
 (707) 263-6838
<http://celake.ucdavis.edu/>

Lassen County
 175 Russell Avenue
 Susanville, CA 96130-4299
 (530) 251-8110
www.co.lassen.ca.us

707 Nevada Street
 Susanville, CA 96130
 (530) 257-2601
<http://celassen.ucdavis.edu/>

Los Angeles County
 12300 Lower Azusa Road
 Arcadia, CA 91005
 (626) 575-5472
<http://www.acwvn.co.la.ca.us>

4800 Cesar Chavez Ave.
 Los Angeles, CA 90022
 (323) 260-2267
<http://celosangeles.ucdavis.edu/>

Madera County
 332 Madera Avenue
 Madera, CA 93637-5499
 (559) 675-7876
www.madera-county.com/agcommissioner/

328 Madera Avenue
 Madera, CA 93637
 (559) 675-7879
<http://cemadera.ucdavis.edu/>

Agriculture Commissioner	Cooperative Extension Office	Agriculture Commissioner	Cooperative Extension Office
Marin County 1682 Novato Boulevard, Suite 150-A Novato, CA 94947-7021 (415) 499-6700 www.co.marin.ca.us/depts/AG/main/	1682 Novato Boulevard, Suite 150-B Novato, CA 94947 (415) 499-4204 http://cemarin.ucdavis.edu/	Nevada County 255 S. Auburn Street Grass Valley, CA 95945-7289 (530) 273-2648 http://new.mynevadacounty.com/	11477 E Avenue Auburn, CA 95603 (530) 889-7385 http://ceplacer.ucdavis.edu/
Mariposa County 5009 Fairground Road/P.O. Box 905 Mariposa, CA 95338-0905 (209) 966-2075 www.mariposacounty.org	5009 Fairgrounds Road Mariposa, CA 95338-9435 (209) 966-2417 http://cemariposa.ucdavis.edu/	Orange County 1750 Douglas Road, Bldg. D Anaheim, CA 92806-6031 (714) 447-7100 www.ocagcomm.com/	1045 Arlington Drive, Gate 4 Costa Mesa, CA 92626 (714) 708-1606 http://ceorange.ucdavis.edu/
Mendocino County 890 North Bush Street Ukiah, CA 95482-3745 (707) 463-4208 www.co.mendocino.ca.us	890 North Bush Street Ag Center/Courthouse Ukiah, CA 95482 (707) 463-4495 http://cemendocino.ucdavis.edu/	Placer County 11477 E Avenue Auburn, CA 95603-2799 (530) 889-7372 www.placer.ca.gov/agriculture/agri.htm	11477 E Avenue Auburn, CA 95603 (530) 889-7385 http://ceplacer.ucdavis.edu/
Merced County 2139 Wardrobe Avenue Merced, CA 95340-6495 (209) 385-7431 www.co.merced.ca.us/ag/	2145 Wardrobe Avenue Merced, CA 95340-6496 (209) 385-7403 http://cemerced.ucdavis.edu/	Plumas/Sierra Counties 208 Fairgrounds Road Quincy, CA 95971-9462 (530) 283-6365 www.countyofplumas.com/ www.sierracounty.ws	208 Fairgrounds Road Quincy, CA 95971 (530) 283-6270 http://ucce-plumas-sierra.ucdavis.edu/
Modoc County 202 W. Fourth Street Alturas, CA 96101-3915 (530) 233-6401 www.infopeople.org/modoc/codept.html	202 W. Fourth Street Alturas, CA 96101 (530) 233-6400 http://ceinyo-mono.ucdavis.edu/	Riverside County 4080 Lemon Street, Room 19 P.O. Box 1089 Riverside, CA 92502-1089 (951) 955-3000 www.rivcoag.org	21150 Box Springs Road, Suite 2 Moreno Valley, CA 92557-8708 (951) 683-6491 http://ceriverside.ucdavis.edu/
Monterey County 1428 Abbott Street Salinas, CA 93901-3915 (831) 759-7325 www.co.monterey.ca.us/ag/	1432 Abbott Street Salinas, CA 93901 (831) 759-7350 http://cemonterey.ucdavis.edu/	Sacramento County 4137 Branch Center Road Sacramento, CA 95827-3897 (916) 875-6603 www.saccounty.net/agcomm/index.html	4145 Branch Center Road Sacramento, CA 95827-3898 (916) 875-6913 http://cesacramento.ucdavis.edu/
Napa County 1710 Soscol Avenue, Suite 3 Napa, CA 94559-1315 (707) 253-4357 www.co.napa.ca.us/	1710 Soscol Avenue, Suite 4 Napa, CA 94559-1315 (707) 253-4221 http://cenapa.ucdavis.edu/		

Agriculture Commissioner	Cooperative Extension Office	Agriculture Commissioner	Cooperative Extension Office
San Benito County 3224 Southside Road/ P.O. Box 699 Hollister, CA 95024 (831) 637-5344 www.san-benito.ca.us/	649 San Benito Street, Suite 115 Hollister, CA 95023-3952 (831) 637-5346 http://cesanbenito.ucdavis.edu/	Santa Barbara County 263 Camino del Remedio Santa Barbara, CA 93110-1335 (805) 681-5600 www.countyofsb.org/agcomm	Santa Barbara Office: 305 Camino del Remedio Santa Barbara, CA 93110-1335 (805) 692-1730 http://cesantabarbara.ucdavis.edu/ Santa Maria Office: 624 W. Foster Road, Suite A Santa Maria, CA 93455 (805) 934-6240
San Bernardino County 777 East Rialto Avenue San Bernardino, CA 92415-0720 (909) 387-2115 www.sbcounty.gov	777 East Rialto Avenue San Bernardino, CA 92415-0730 (909) 387-2171 http://cesanbernardino.ucdavis.edu/	Santa Clara County 1553 Berger Drive, Bldg. #1 San Jose, CA 95112-2795 (408) 918-4600 www.sccagriculture.org/	1553 Berger Drive, Bldg. #1 San Jose, CA 95112 (408) 282-3110 http://cesantclara.ucdavis.edu/
San Diego County 5555 Overland Avenue, Bldg. 3 San Diego, CA 92123-1292 (858) 694-2741 www.sdcawmn.org	5555 Overland Avenue, Bldg. 4 San Diego, CA 92123-1219 (858) 694-2845 http://cesandiego.ucdavis.edu/	Santa Cruz County 175 Westridge Drive Watsonville, CA 95076-2797 (831) 763-8080 www.co.santa-cruz.ca.us/	1432 Freedom Boulevard Watsonville, CA 95076-2796 (831) 763-8040 http://cesantacruz.ucdavis.edu/
San Francisco County 1390 Market Street, Suite 822 San Francisco, CA 94102 (415) 252-3830 http://www.sfdph.org/eh/Agriculture.shtml	80 Stone Pine Road #100 Half Moon Bay, CA 94019 (650) 726-9059	Shasta County 3179 Bechelli Lane, Suite 210 Redding, CA 96002-2041 (530) 224-4949 www.co.shasta.ca.us	Shasta County Office: 1851 Hartnell Avenue Redding, CA 96002-2217 (530) 224-4900 http://ceshasta.ucdavis.edu/ Shasta-Lassen Office: 44218 A. Street/P.O. Box #9 McArthur, CA 95056-0009 (530) 336-5784 http://ceshastalassen.ucdavis.edu/
San Joaquin County 1868 E. Hazelton Avenue/ P.O. Box 1809 Stockton, CA 95201-1809 (209) 468-3300 www.sjgov.org	420 South Wilson Way Stockton, CA 95205 (209) 468-2085 http://cesanjoaquin.ucdavis.edu/	Siskiyou County 525 South Foothill Drive Yreka, CA 96097-3090 (530) 841-4025 www.co.siskiyou.ca.us	1655 South Main Street Yreka, CA 96097 (916) 842-2711 http://cesiskiyou.ucdavis.edu/
San Luis Obispo County 2156 Sierra Way, Suite A San Luis Obispo, CA 93401-4556 (805) 781-5910 www.sloag.org	2156 Sierra Way, Suite C San Luis Obispo, CA 93401 (805) 781-5940 http://cesanluisobispo.ucdavis.edu/		
San Mateo County 728 Heller Street/P.O. Box 999 Redwood City, CA 94064-0999 (650) 363-4700 www.co.sanmateo.ca.us	80 Stone Pine Road #100 Half Moon Bay, CA 94019 (650) 726-9059 http://cesanmateo.ucdavis.edu/		

Agriculture Commissioner	Cooperative Extension Office	Agriculture Commissioner	Cooperative Extension Office
Solano County 501 Texas Street Fairfield, CA 94533 (707) 784-1310 www.co.solano.ca.us/	501 Texas Street Fairfield, CA 94533-4498 (707) 784-1317 http://cesolano.ucdavis.edu/	Tulare County 4437 S. Laspina Street, Suite Tulare, CA 93274 (559) 685-3323 http://agcomin.co.tulare.ca.us/	4437 S. Laspina Street, Suite B Tulare, CA 93274 (559) 685-3303 http://cetulare.ucdavis.edu/
Sonoma County 133 Aviation Blvd., Suite 110 Santa Rosa, CA 95403-2893 (707) 565-2371 www.sonoma-county.org/agcomm/index.htm	133 Aviation Blvd., Suite 109 Santa Rosa, CA 95403-2894 (707) 565-2621 http://cesonoma.ucdavis.edu/	Tuolumne County 22365 S. Airport Road/ 2 S. Green Street Columbia/Sonora, CA 95370-4617 (209) 533-5691 http://www.infonctc.org/	2 S. Green Street Sonora, CA 95370 (209) 533-5695 http://cetuolumne.ucdavis.edu/
Stanislaus County 3800 Cornucopia Way, Suite B Modesto, CA 95358 (209) 525-4730 www.co.stanislaus.ca.us	3800 Cornucopia Way, Suite B Modesto, CA 95358 (209) 525-6800 http://cestanislaus.ucdavis.edu/	Ventura County 815 E. Santa Barbara Street P.O. Box 89 Ag Building Santa Paula, CA 93061-0889 (805) 933-8415 www.ventura.org	669 County Square Drive, #100 Ventura, CA 93003-5401 (805) 645-1451 http://ceventura.ucdavis.edu/
Sutter County 142 Garden Highway Yuba City, CA 95991-5512 (530) 822-7500 www.suttercounty.org/doc/government/depts/ag/aghome	142-A Garden Highway Yuba City, CA 95991-5593 (530) 822-7515 http://cesutter.ucdavis.edu/	Yolo County 70 Cottonwood Street Woodland, CA 95695-2593 (530) 666-8140 www.yolocounty.org	70 Cottonwood Street Woodland, CA 95695 (530) 666-8143 http://ceyolo.ucdavis.edu/
Tehama County 1760 Walnut Street/P.O. Box 38 Red Bluff, CA 96080 (530) 527-4504 www.tehamacountyadmin.org/index.cfm	1754 Walnut Street Red Bluff, CA 96080 (530) 527-3101 http://cetehama.ucdavis.edu/	Yuba County 915 8th Street, Suite 127 Marysville, CA 95901-4192 (530) 749-5400 www.co.yuba.ca.us	(see Sutter County) 142-A Garden Highway Yuba City, CA 95991-5593 (530) 822-7515
Trinity County 173 Tom Bell Road Box 1466 Weaverville, CA 96093-1466 (530) 623-1356 www.trinitycounty.org	P.O. Box 490 Hayfork, CA 96041 (530) 628-5495 http://cctrinity.ucdavis.edu/		

Pesticide Poisoning Emergencies

California

Managed by University of California, San Francisco, School of Pharmacy, the California Poison Control System consist of four answering sites:

Poison Control System

- UC Davis Medical Center, Sacramento
- San Francisco General Hospital, San Francisco
- Valley Children's Hospital, Fresno
- UC San Diego Medical Center, San Diego

In a poisoning emergency, the Poison Control System can be reached from throughout California by using a single toll-free number:

1-800-876-4766 (1-800-8-POISON)
TTY 1-800-972-3323

Health education services are available throughout the state. For information regarding pamphlets, stickers, or presentations call: 1-800-582-5387.

Outside of California, call
1-800-222-1222

Useful Resources for Pesticide Handling and Pest Management

PESTICIDE HANDLING

UC Publications

The Safe and Effective Use of Pesticides - #3324

La lotería de los pesticidas (Spanish-language pesticide safety training game) - #3355

The Illustrated Guide to Pesticide Safety, Instructor's Edition (Spanish and English) - #21489

Jorge's New Job (A Guide to Cholinesterase Testing for Workers in Spanish and English) - #21507

UC Videos

Jorge's New Job: The Importance of Cholinesterase Testing (English, Spanish)

Long-Term Health Effects of Pesticide Exposure

Pesticide Safety for Small Farms (English, Spanish, Hmong, Ilokano, and Lao)

Pesticide Safety in the Greenhouse (English, Spanish)

Protecting Yourself from Pesticide Hazards in the Workplace (English/Spanish)

Reducing Pesticide Risks: An Interactive Program for Training Pesticide Handlers (English/Spanish)

Safe Handling of Pesticides (English, Spanish)

Field Worker Pesticide Safety for Mixtec Workers (videos or CDs)

Available from Department of Pesticide Regulation, Worker Health and Safety Branch, P.O. Box 4015, Sacramento, CA 95812-4015, (916) 445-4261, Attention: Charlene Marrans

PEST MANAGEMENT

UC IPM Pest Management Guidelines

Available *Guidelines* include: alfalfa; almonds; apples; apricots; artichokes; asparagus; avocados; bermudagrass; caneberries; carrots; celery; cherries; citrus; cole crops; corn; cotton; cucurbits; dry beans; figs; grapes; kiwifruit; lettuce; nectarines; olives; onions and garlic; peaches; pears; pecans; peppermint; peppers; pistachios; plums; potatoes; prunes; rice; small grains; spinach; strawberries; sugarbeets; tomatoes; and walnuts.

Also available: floriculture and ornamental nurseries and turfgrass.

Guidelines are available on the World Wide Web at <http://www.ipm.ucdavis.edu> or from UCCE offices.

UC IPM Manuals

Available Manuals include:

IPM for Alfalfa Hay - #3312

IPM for Almonds - #3308

IPM for Apples and Pears - #3340

IPM for Citrus, 2nd edition - #3303

IPM for Cole Crops and Lettuce - #3307

IPM for Cotton - #3305

IPM for Floriculture and Nurseries - #3402

IPM for Potatoes - #3316

IPM for Rice - #3280

IPM for Small Grains - #3333

IPM for Stone Fruits - #3389

IPM for Strawberries - #3351

IPM for Tomatoes - #3274

IPM for Walnuts - #3270

UC IPM Books

IPM in Practice: Principles and Methods of Integrated Pest Management - #3418

Natural Enemies Handbook: The Illustrated Guide to Biological Pest Control - #3386

Pests of the Garden and Small Farm: A Grower's Guide to Using Less Pesticide, 2nd edition - #3332

Pests of Landscape Trees and Shrubs: An Integrated

Pest Management Guide, 2nd edition - #3359

Tree Fruit Pest Identification and Monitoring Cards - #3426

ORDERING INFORMATION

The University of California publications are available through many UC Cooperative Extension offices (see listing in the Appendix) or can be ordered from the following source:

University of California
Agriculture and Natural Resources
Communication Services—Publications
6701 San Pablo Avenue
Oakland, CA 94608-1239

Telephone (510) 642-2431 or (800) 994-8849
FAX (510) 643-5470
<http://anrcatalog.ucdavis.edu>

PESTICIDE HANDLER SAFETY TRAINING RECORD

PRINT EMPLOYEE'S NAME _____ Employee's signature _____ PRINT EMPLOYER'S NAME _____ Employer's signature _____ TRAINER'S NAME/SIGNATURE _____					PESTICIDE NAME									
ASSIGNED JOB DUTIES: <input type="checkbox"/> Mixer/Loader <input type="checkbox"/> Service/Repair <input type="checkbox"/> Flagger <input type="checkbox"/> Applicator <input type="checkbox"/> Other					Trainer's Initials _____ Employee's Initials _____ Date (w/year) _____									
TRAINING REQUIREMENTS:														
LABEL INFORMATION: Signal words, precautionary statements, first aid instructions, mixing and application directions.										TOPICS COVERED FOR ALL PESTICIDES				
HAZARDS OF PESTICIDES: Acute and chronic effects, delayed effects and sensitization. (Labeling, MSDS, PSIS leaflets)														
ROUTES OF EXPOSURE: (Label, MSDS)														
SIGNS AND SYMPTOMS OF OVEREXPOSURE: (Label, PSIS leaflets, MSDS)														
EMERGENCY FIRST AID FOR PESTICIDE OVEREXPOSURE: First aid for skin, eye, inhalation and ingestion exposure. (PSIS A-4, Label instructions, MSDS)														
HOW TO OBTAIN EMERGENCY MEDICAL CARE: Posting of name, address and telephone number of clinic, physician, or hospital emergency room; company policy for reporting illness and obtaining medical treatment.														
ROUTINE AND EMERGENCY DECONTAMINATION PROCEDURES: Need to shower after exposure period, importance of washing hands before eating, drinking, smoking or using the bathrooms, procedures for handling spill clean up. (PSIS A-4, label instructions, MSDS)														
NEED FOR AND APPROPRIATE USE OF PERSONAL PROTECTIVE EQUIPMENT: (Worker safety regulations, Label requirements, PSIS A-1, A-6)														
PREVENTION, RECOGNITION AND FIRST AID FOR HEAT RELATED ILLNESS: (Worker Protection Standards)														
SAFETY REQUIREMENTS AND PROCEDURES FOR HANDLING, TRANSPORTING, STORING AND DISPOSING OF PESTICIDES: Engineering controls (enclosed cabs, closed mixing systems), procedures for opening, lifting, pouring and operating mixing and application equipment.														
ENVIRONMENTAL CONCERNS: Drift, run-off, and wildlife hazards.														
WARNINGS ABOUT TAKING PESTICIDE CONTAINERS HOME														
APPLICABLE LAWS AND REGULATIONS: (Worker safety requirements, Worker Protection Standards, MSDS, PSIS leaflets, labeling requirements)														
MEDICAL SUPERVISION: Purpose and requirements if using Category I or II organophosphates or carbamates. (Covered if required for pesticide)														
LOCATION OF DOCUMENTS: Written Hazard Communication Information (PSIS A-8), Pesticide Safety Information Series leaflets, Material Safety Data Sheets, Pesticide Use records, employee training, exposure and monitoring records.										TOPICS COVERED FOR ALL PESTICIDES				
EMPLOYEE'S RIGHTS: Right to receive information regarding pesticides to which he/she may be exposed; protection from retaliatory action due to exercising their rights.														
RESPIRATOR TRAINING: Written operating procedures for use, selection, fitting, cleaning, inspection, maintenance and limitations. (Label requirements, specific regulations, PSIS A-5, and respirator manufacturer recommendations) (Covered if required for pesticide)														

(Attach additional forms as needed)

Criteria for Fieldworker Training

Training for fieldworkers must include at least the following information and be given to all workers who enter pesticide-treated areas for 30 days following expiration of a restricted-entry interval. Training must be provided to workers when a field has been treated with any type of pesticide, such as herbicides, fungicides, and insecticides. Training is not required if workers or employers can verify such training has been provided within the past five years.

INFORMATION THAT MUST BE COVERED

- | | |
|---|---|
| <ul style="list-style-type: none"> ■ Where and how workers may come in contact with pesticides or pesticide residues during work, including hazards from chemigation and drift. ■ Importance of <i>routine</i> decontamination and washing after exposure. ■ The routes by which pesticides can enter the body (skin, mouth, inhalation, and eyes). ■ Symptoms of acute pesticide poisoning or injury, and long-term and delayed health effects from pesticide exposure, including sensitization. ■ First aid for pesticide injury and poisoning, and emergency decontamination. | <ul style="list-style-type: none"> ■ How workers can protect themselves from exposure—clothing; avoiding skin, eye, and mouth contact; personal hygiene. ■ Obtaining medical help. ■ After-work care of contaminated work clothes. ■ Warnings about taking home pesticides or pesticide containers. ■ An explanation of the entry restrictions, application limitations, posting, oral warnings, access to pesticide use information, and protection from employer retaliation. ■ Hazard communication program requirements and employee rights (Pesticide Safety Information Series A-9) |
|---|---|

FIELDWORKER PESTICIDE TRAINING RECORD

Trainer's Name:	<input type="text"/>	Date:	<input type="text"/>
Trainer's Signature:	<input type="text"/>	Location:	<input type="text"/>

Trainee's Name (print)	Signature	EPA Card #
1.		
2.		
3.		
4.		
5.		
6.		
7.		
8.		
9.		
10.		

This training complied with training requirements for fieldworkers and included the following information:

- Importance of routine decontamination and washing thoroughly after the exposure period
- Restricted entry intervals and what posting means, including California and federal field posting sign formats
- Where and how workers may come in contact with pesticide or pesticide residues during work, including treated surfaces in the field and residues on clothing
- The routes by which pesticides can enter the body (skin, mouth, inhalation, eyes)
- Effects of acute pesticide poisoning or injury; chronic and delayed health effects from pesticide exposure; and sensitization effects
- Common signs and symptoms of overexposure
- How workers can protect themselves from the hazards of pesticide exposure: clothing; avoiding skin, eye and mouth contact; personal hygiene
- First aid for pesticide injury and poisoning and decontamination, eye flushing, and the need to get medical care
- Obtaining medical help
- After-work care of contaminated work clothes
- Warnings about taking home pesticides or pesticide containers
- An explanation of the hazard communication program requirements including access to pesticide use information and protection from employer retaliation

TRAINING AND INSTRUCTIONS FOR EARLY-ENTRY WORKERS

Early-entry workers are those who enter a treated field or any other area after the pesticide application is complete, but before the restricted entry interval or other restrictions on entry for that pesticide have expired.

Basic Responsibilities

Worker employers must make sure that each of their early-entry workers is currently trained and, in addition, receives specific information and instructions, described below. Assure that at least one pint of eye flush water is immediately accessible to each fieldworker when the pesticide labeling requires protective eyewear.

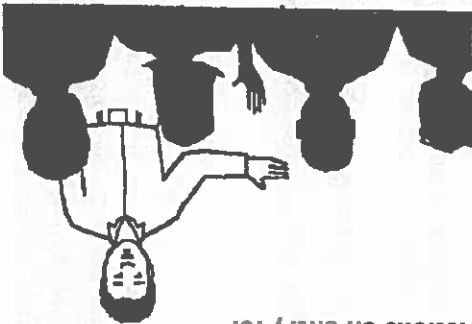

Specific Duties

Training
 Make sure that each early-entry worker is currently trained before entering a treated area during a restricted-entry interval.

Instructions Related to Personal Protective Equipment (PPE)

Instruct early-entry workers, in a manner they can understand:

- How to put on, use and take off early-entry PPE correctly
- The importance of washing thoroughly after removing PPE at the end of the exposure period
- How to prevent, recognize, and give correct first aid for heat related illness

Labeling Information and Instructions

Inform early-entry workers, in a manner they can understand, about the safety information and instructions on the labeling of the pesticide to which the reentry interval applies, including:

- Human hazard statements and precautions
- First aid
- Signs and symptoms of poisoning
- Use and care of PPE required for early entry
- Any other precautions or instructions related to safe use or early entry

Limitations

- Entry into treated fields during reentry intervals to perform soil incorporation of pesticides requires wearing the PPE specified on the pesticide product labeling.
- An employee may enter a treated field during a restricted entry interval when there will be no contact with anything that has been treated, including soil, water, air, equipment, or plant surfaces, providing that the inhalation exposure does not exceed pesticide labeling standards.
- Limited contact activities (including limited contact irrigation) that are necessary and unforeseen are permitted as long as restricted entry interval is not for a pesticide which requires both oral and posting notification for reentry
- 1. at least 4 hours have elapsed since the end of the application *
- 2. inhalation exposure does not exceed the pesticide label standard *
- 3. exposure is minimal and limited to the feet, legs (below the knees), hands and forearms (below the elbows)
- * 4. time in the field does not exceed 8 hours in a 24 hour period *
- 5. PPE specified on the pesticide label for early entry is utilized
- 6. employee is informed orally or by posting of items 2,3, and 6 above
- An employee may enter a treated field during the restricted entry interval to conduct other activities that do not involve hand labor provided that
 1. at least 4 hours have elapsed since the end of the application
 2. inhalation exposure does not exceed pesticide label standards
 3. PPE specified on the label for early entry is used
 4. entry does not exceed 1 hour in any 24-hour period

California Restricted-Entry Intervals

U.S. EPA restricted-entry intervals can be found on pesticide labels. This is the period of time in which people must be kept out of a pesticide-treated area. California regulations establish longer restricted-entry intervals for certain high-hazard pesticides for greater protection to people. Following are excerpts from the California Code of Regulations, Section 6772 and 6774, which list restricted-entry intervals for specific pesticides and how they change when combinations are applied. These regulations change periodically, so contact your local county Agricultural Commissioner for current intervals and for any additional local restrictions.

6772. Restricted-Entry Intervals.

- (a) The restricted-entry intervals specified in this section shall be applied according to the following:
- (1) Other restricted-entry intervals are found on pesticide product labeling. In case of an inconsistency between the pesticide product labeling and this section, the longer restricted-entry interval shall be followed;
 - (2) If more than one restricted-entry interval in this section is applicable to a given situation, the longer restricted-entry interval shall apply, except as provided in section 6774;
 - (3) When reference is made to pounds of a pesticide in a restricted-entry interval, the reference means pounds of active ingredient;
 - (4) A day is considered to be a 24-hour period beginning at the conclusion of the application of the application field or portion of a field;
- (b) The restricted-entry intervals in days in the following table apply to the pesticide/crop combinations listed.

CHEMICAL	Apples	Citrus	Corn	Grapes	Peaches/ Nectarines	Other Crops
Azinphos-methyl	14 ^a	30		21	14 ^b	14 ^{a,b}
Chlorpyrifos			2			
Diazinon	5			5	5	
Endosulfan	2	2	2	2	2	2
Malathion		1		1	1	
Methodathion (Surpricide)			30			
Methomyl (Lannate)				7 ^c		
Parathion-methyl	14	14 ^b	14 ^b	14 ^e	21	14 ^b
Phorate (Thimet)				7		
Phosmet (Imidan)				5	5	
Propargite (Omite/Comite)	21	42	7	30	21	21 ^{f,g}
Sulfur				3 ^h		

Footnotes:

- A**—This restricted-entry interval applies to stone fruit only. Stone fruit does not include almonds and other nut crops.
- B**—If the total Azinphos-methyl applied in the current calendar year is 1.0 pounds per acre or less, thinning may be done after 7 days.
- C**—Applications of methomyl made after August 15 have a 21 day restricted entry interval. This interval may be terminated after 10 days if leaf samples tested pursuant to section 6774(c) (4) show 0.1 micrograms per square centimeter or less of dislodgeable foliar residue of methomyl.
- D**—This restricted-entry interval applies only when more than one pound per acre of non-encapsulated parathion-methyl is applied.
- E**—The restricted-entry interval for non-encapsulated parathion-methyl on grapes in Monterey County is 6 days.
- F**—The restricted-entry interval for strawberries and field-grown roses treated with propargite is 3 days.
- G**—The restricted-entry interval for cotton fields treated with propargite is 7 days. However, from the end of the restricted entry interval until the beginning of harvest, the employer shall assure that employees entering propargite-treated cotton fields wear work clothing with long sleeves and legs and gloves.
- H**—This restricted-entry interval for sulfur applies from May 15 through harvest in the counties of: Fresno, Kern, Kings, Madera, Merced, San Joaquin, Stanislaus, and Tulare; and during March and April in Riverside County.

6774. Restricted Entry Interval Adjustments.

- (b) Whenever a mixture of two or more organophosphate pesticides is applied, the restricted entry interval shall be lengthened by adding to the longest applicable restricted entry interval listed in 6772, 50 percent of the next longest applicable restricted entry interval.

Organophosphate and N-Methyl Carbamate Pesticides

Following are common organophosphate and N-methyl carbamate pesticides. Pesticide handlers who handle these or other organophosphate or N-methyl carbamate insecticides with the signal words *Danger* or *Warning* for more than six days in any 30-day period must be under medical supervision. Medical supervision includes monitoring cholinesterase levels. Pesticide handlers are employees who mix, load, or apply pesticides, clean or repair pesticide-contaminated equipment, work as flaggers, or handle opened containers.

ORGANOPHOSPHATES

Def[®]
 diazinon
 Dibrom[®]
 dimethoate
 Di-Syston[®]
 Dursban[®]
 Dyfonate[®]
 Dylox[®]
 ethion
 Fenthion[®]
 Folex[®]
 Guthion[®]
 Imidan[®]

N-METHYL CARBAMATES

Baygon[®]
 Carzol[®]
 Furadan[®]
 Ficam[®]
 Lannate[®]

MesuroI[®]
 Sevin[®]
 Temik[®]
 Vydate[®]

STATE OF CALIFORNIA
DEPARTMENT OF FOOD AND AGRICULTURE
PRODUCTION AGRICULTURE MONTHLY PESTICIDE USE REPORT

MONTH 1 YEAR 2 NURSERY 3 Page 01

OPERATOR ID/PERMIT NO. 5 OPERATOR (GROWER) ADDRESS 6 CITY 7 ZIP CODE B
 SITE ID NO. 10 TOTAL PLANTED ACREAGE/UNITS COUNTY NO. 11 SECTION 12 TOWNSHIP 13 RANGE N 14 BASE & MERIDIAN E 15
 COMMODITY/SITE TREATED FIELD LOCATION 19 DAYS RESIDUE 28 RATE PER ACRE 29 DILUTION 30 PRODUCT/MANUFACTURER 31

17 CHEMICAL NUMBER	18 DATE/TIME APPLICATION COMPLETED	23 ACREAGE/UNITS TREATED	24 APP. MATH. CHECK (ONE)	25 BLOCK ID (IF APPLICABLE)	26 EPA/CALIF. REG. NO FROM LABEL	27 TOTAL PRODUCT USED (CIRCLE ONE UNIT OR MEASURE)	28 DAYS RESIDUE	29 RATE PER ACRE	30 DILUTION	31 PRODUCT/MANUFACTURER
			GR <input type="checkbox"/> AIR <input type="checkbox"/> OTHER <input type="checkbox"/>			LB OZ PT QT GA				
			GR <input type="checkbox"/> AIR <input type="checkbox"/> OTHER <input type="checkbox"/>			LB OZ PT QT GA				
			GR <input type="checkbox"/> AIR <input type="checkbox"/> OTHER <input type="checkbox"/>			LB OZ PT QT GA				
			GR <input type="checkbox"/> AIR <input type="checkbox"/> OTHER <input type="checkbox"/>			LB OZ PT QT GA				
			GR <input type="checkbox"/> AIR <input type="checkbox"/> OTHER <input type="checkbox"/>			LB OZ PT QT GA				
			GR <input type="checkbox"/> AIR <input type="checkbox"/> OTHER <input type="checkbox"/>			LB OZ PT QT GA				
			GR <input type="checkbox"/> AIR <input type="checkbox"/> OTHER <input type="checkbox"/>			LB OZ PT QT GA				
			GR <input type="checkbox"/> AIR <input type="checkbox"/> OTHER <input type="checkbox"/>			LB OZ PT QT GA				
			GR <input type="checkbox"/> AIR <input type="checkbox"/> OTHER <input type="checkbox"/>			LB OZ PT QT GA				
			GR <input type="checkbox"/> AIR <input type="checkbox"/> OTHER <input type="checkbox"/>			LB OZ PT QT GA				
			GR <input type="checkbox"/> AIR <input type="checkbox"/> OTHER <input type="checkbox"/>			LB OZ PT QT GA				
			GR <input type="checkbox"/> AIR <input type="checkbox"/> OTHER <input type="checkbox"/>			LB OZ PT QT GA				
			GR <input type="checkbox"/> AIR <input type="checkbox"/> OTHER <input type="checkbox"/>			LB OZ PT QT GA				
			GR <input type="checkbox"/> AIR <input type="checkbox"/> OTHER <input type="checkbox"/>			LB OZ PT QT GA				
			GR <input type="checkbox"/> AIR <input type="checkbox"/> OTHER <input type="checkbox"/>			LB OZ PT QT GA				
			GR <input type="checkbox"/> AIR <input type="checkbox"/> OTHER <input type="checkbox"/>			LB OZ PT QT GA				
			GR <input type="checkbox"/> AIR <input type="checkbox"/> OTHER <input type="checkbox"/>			LB OZ PT QT GA				
			GR <input type="checkbox"/> AIR <input type="checkbox"/> OTHER <input type="checkbox"/>			LB OZ PT QT GA				
			GR <input type="checkbox"/> AIR <input type="checkbox"/> OTHER <input type="checkbox"/>			LB OZ PT QT GA				
			GR <input type="checkbox"/> AIR <input type="checkbox"/> OTHER <input type="checkbox"/>			LB OZ PT QT GA				
			GR <input type="checkbox"/> AIR <input type="checkbox"/> OTHER <input type="checkbox"/>			LB OZ PT QT GA				

REPORT PREPARED BY _____ DATE _____ 33-017C (3/90)
 Submitted to Agricultural Commissioner within 10 days of month following application

REVIEWED BY _____ For Agency Use Only

Pesticide Safety Information Series

Following is a list of the Pesticide Safety Information Series (PSIS) publications produced by the California Department of Pesticide Regulation, Worker Health and Safety Branch. These are available from agricultural commissioner's office and are a useful worker training aid. Text for all Pesticide Safety Information Series leaflets can be downloaded in English, Spanish, or Punjabi at <http://www.cdpr.ca.gov/docs/whs/psisenglish>.

- | | |
|----------------------|--|
| PSIS A-1 | Working Safely with Pesticides on Farms |
| PSIS A-1(S) | El Trabajo con Pesticidas Sin Peligro En Los Campos Agrícolas |
| PSIS A-2 | Storing, Moving and Disposing of Pesticides on Farms |
| PSIS A-2(S) | Almacenaje, Traslado y Eliminación De Pesticidas En Los Campos Agrícolas |
| PSIS A-3 | Closed Systems, Enclosed Cabs, Water-Soluble Packaging |
| PSIS A-3(S) | Sistemas Cerrados, Cabinas Cerradas, Envases Solubles En Agua |
| PSIS A-4 | First Aid |
| PSIS A-4(S) | Primeros Auxilios |
| PSIS A-5 | Protecting Yourself from Breathing Pesticides on Farms |
| PSIS A-5(S) | Protejase Usted Mismo de Respirar Pesticidas En Los Campos Agrícolas |
| PSIS A-7 | Washing Pesticide Work Clothing |
| PSIS A-7(S) | El Lavado De Ropa De Trabajo Que Tiene Pesticida |
| PSIS A-8 | Safety Rules for Pesticide Handlers on Farms |
| PSIS A-8(S) | Normas De Seguridad Para Los Que Manejan Pesticidas En Los Campos Agrícolas |
| PSIS A-9 | Pesticide Safety Rules for Farmworkers |
| PSIS A-9(S) | Normas De Seguridad Con Pesticidas Para Los Trabajadores Agrícolas |
| PSIS A-10 | Safety Rules for Minimal Exposure Pesticides on Farms |
| PSIS A-10(S) | Normas De Seguridad Para Los Pesticidas De Exposición Mínima (MEPs) En Los Campos Agrícolas |
| PSIS A-11 | Rules for Medical Care When Handlers Use Organophosphates and Carbamates |
| PSIS A-11 (S) | Normas Para El Cuidado Médico Cuando Los Manipuladores Usan Organofosforados y Carbamatos |

Procedures for Triple Rinsing Pesticide Containers

All empty pesticide containers will contain significant pesticide residues unless they are properly cleaned. Containers that have not been cleaned by triple rinsing are considered hazardous waste and must be transported to a Class 1 disposal site. Triple rinsed containers may be taken to a Class 2 disposal site or transported to pesticide container recycling facilities. Containers may need to be inspected by the local county Agricultural Commissioner's office to verify they have been cleaned.

It is illegal to use empty pesticide containers for any purpose. After triple rinsing, containers must be disposed of. Store empty containers in a locked area until they are transported to the disposal or pesticide recycling site. Puncture containers after triple rinsing to make sure they cannot be used.

Follow the steps listed below to properly triple rinse containers that have held liquid pesticides:

1. When the container is empty, let it drain into your spray or mixing tank for at least 30 seconds.
2. Add the following amount of water to the container:

Container Size	Amount of Water to Add
Less than 1 gallon	¼ of the container volume
1 gallon	1 quart
5 gallons	1 gallon
>5 gallons	½ container volume

3. Tightly close the container.
4. Shake the container, or roll drums, to get rinse water on all interior surfaces.
5. Remove cap and drain the container into your sprayer or mixing tank. After it is empty, let it drain for an additional 30 seconds.
6. Repeat steps 2 through 5 two additional times to further remove pesticide residues.

After emptying and draining a 5-gallon pesticide container, there will be approximately 1 ounce of formulated material remaining in the container. If this were a 50% active ingredient formulation, approximately 14.1875 grams of active ingredient would still be present. During the first rinsing, all but 0.2183 grams of active ingredient would be removed. This would be reduced to 0.0034 grams of active ingredient by the second rinsing. After the third and final rinse, only 0.00005 grams of active ingredient would remain. You will have removed 99.99648% of the pesticide active ingredient!

Avoiding Heat Related Illness

Heat related illness occurs when the body builds up more heat than it can cope with. It is a group of medical conditions that result from the body's inability to cope with a head load. It includes heat cramps, heat exhaustion, and heatstroke. Growers should know about the different types of heat related illnesses and be able to recognize the common symptoms and signs. If these are not addressed, the illness can progress



to a very serious medical condition. Factors which contribute to heat related illness include temperature, sun exposure, humidity, and air movement. Work conditions, such as the level of exertion, rest and meal breaks, water consumed, and the use of protective clothing all can influence the body's reac-

tion to heat. Heat related illness is not caused by exposure to pesticides, but may affect pesticide handlers who are working in hot conditions. Wearing personal protective equipment—clothing and devices that protect the body from contact with pesticides—can increase the risk of heat related illness by limiting the body's ability to cool down.

- drinking water intake
- scheduling

Heat and Workload

High temperatures, high humidity, and sunlight increase the likelihood of heat related illness. Air movement, from wind or from fans, may provide cooling. Because hard work causes the body to produce heat, a person is more likely to develop heat related illness when working on foot than when driving a vehicle. Lifting or carrying heavy containers or equipment also increases the likelihood of becoming overheated.

AVOID HEAT RELATED ILLNESS

Several factors work together to cause heat related illness. Before beginning a pesticide handling task, think about whether any of these factors are likely to be a problem. Consider making adjustments in the task itself or in the workplace conditions, including:

- heat factors—temperature, humidity, air movement, and sunlight
- workload—the amount of effort a task takes
- personal protective equipment (PPE)

SIGNS AND SYMPTOMS OF HEAT RELATED ILLNESS

Heat related illness, even in mild forms, makes people feel ill and impairs their ability to do a good job. They may get tired quickly, feel weak, be less alert, and be less able to use good judgment. Severe heat related illness and heatstroke are serious illnesses. Unless



victims are cooled quickly, they can die. Severe heat related illnesses are fatal to more than 10 percent of its victims, even young, healthy adults. Victims may remain sensitive to heat for months and be unable to return to the same work.

Learn the signs and symptoms of heat related illness and take immediate action to cool down if they appear. Signs and symptoms may include:

- fatigue (exhaustion, muscle weakness)
- headache, nausea, and chills
- dizziness and fainting
- loss of coordination
- severe thirst and dry mouth
- altered behavior (confusion, slurred speech, quarrelsome or irrational attitude)

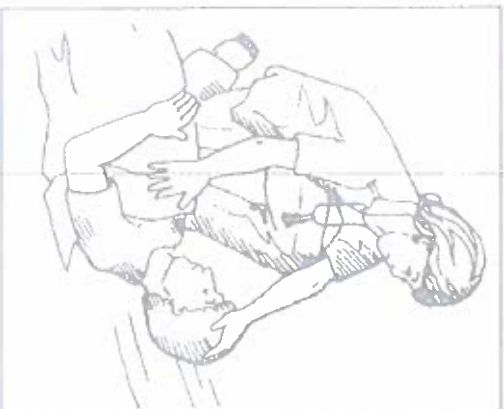

An early sign of heat related illness is heat cramps, which can be painful. These are muscle spasms in the legs, arms, or stomach caused by loss of body salts through heavy sweating. To relieve cramps, drink cool water. Stretching or kneading the muscles may temporarily relieve the cramps. If there is a chance that stomach cramps are being caused by pesticides rather than salt loss, get medical help right away. Heat exhaustion is a more serious illness, with weakness, nausea, dizziness, and profuse sweating. Heatstroke is the most serious heat related illness and victims cease sweating, have very high body temperatures, and collapse. This is a medical emergency! Call 9-1-1 and seek help immediately.

FIRST AID FOR HEAT RELATED ILLNESS

It is not always easy to tell the difference between heat related illness and pesticide poisoning. The signs and symptoms are similar. Don't waste time trying to decide what is causing the illness. Get medical help right away.

- Cool victim as rapidly as possible by sponging or splashing the skin, especially around the face, neck, hands, and forearms, with cool water or, when possible, immersing in cool water.
- Carefully remove all PPE and any other clothing that may be making the victim hot.
- Have the victim, if conscious, drink as much cool water as possible.
- Keep the victim quiet until help arrives.
- Heat stroke is a medical emergency! Cool victim immediately. Brain damage and death may result if treatment is delayed.
- Call 9-1-1.

Useful Conversion Factors for Calibration

STANDARD MEASURE

1 ft = 12 in
 1 yd = 3 ft
 1 mi = 5,280 ft

METRIC CONVERSIONS

Length

1 in = 25.4 mm = 2.54 cm
 1 ft = 304.8 mm = 30.48 cm
 1 yd = 914.4 mm = 91.44 cm
 = 0.914 m
 1 mi = 1,609 m = 1.61 km
 1 mm = 0.3937 in
 1 cm = 0.394 in = 0.0328 ft
 1 m = 39.37 in = 3.281 ft
 1 km = 3,281 ft = 0.6214 mi

Area

1 sq in = 0.007 sq ft
 1 sq ft = 144 sq in = 0.000023 sq ac
 1 sq yd = 1,296 sq in = 9 sq ft
 1 ac = 43,560 sq ft = 4,840 sq yd
 1 sq in = 6.45 sq cm
 1 sq ft = 929 sq cm
 1 sq yd = 8,361 sq cm = 0.8361 sq m
 1 ac = 4,050 sq m = 0.405 h
 1 sq cm = 0.155 sq in
 1 sq m = 1,550 sq in = 10.76 sq ft
 1 h = 107,600 sq ft = 2.47 ac

Volume

1 tsp = 0.17 fl oz
 1 tbs = 3 tsp
 1 fl oz = 2 tbs = 6 tsp
 1 cup = 8 fl oz = 16 tbs
 1 pt = 2 cups = 16 fl oz
 1 qt = 2 pt = 32 fl oz
 1 gal = 4 qt = 8 pt = 128 fl oz
 = 231 cu in
 1 fl oz = 29.5 ml = 0.0295 l
 1 pt = 437 ml = 0.437 l
 1 qt = 945 ml = 0.945 l
 1 gal = 3785 ml = 3.785 l
 1 ml = 0.033 fl oz
 1 l = 33.8 fl oz = 2.112 pt = 1.057 qt
 = 0.264 gal

STANDARD MEASURE

1 oz = 0.0625 lb
 1 lb = 16 oz
 1 ton = 2,000 lb
 1 gallon of water = 8.34 lb

METRIC CONVERSIONS

Weight

1 oz = 28.35 g
 1 lb = 454 g = 0.4536 kg
 1 ton = 907 kg
 1 gallon of water = 3.786 kg
 1 g = 0.035 oz
 1 kg = 35.27 oz = 2.205 lb

Abbreviations

ac: acre
 fl oz: fluid ounce
 ft: foot or feet
 gal: gallon
 in: inch
 lb: pound
 mi: mile
 oz: ounce
 pt: pint
 qt: quart
 sq: square
 tbs: tablespoon
 tsp: teaspoon
 yd: yard
 cm: centimeter
 g: gram
 h: hectare (1 h = 10,000 sq m)
 kg: kilogram
 km: kilometer
 l: liter
 m: meter
 ml: milliliter
 mm: millimeter

GLOSSARY

absorb. To soak up or take in a liquid or powder.

acute illness. An illness that becomes apparent soon after an exposure to a pesticide occurs.

acute onset. Symptoms of pesticide-related injury appear soon after the exposure incident.

adjuvant. A material added to a pesticide mixture to improve or alter the deposition, toxic effects, mixing ability, persistence, or other qualities of the active ingredient.

air gap. A space between the filling hose and the liquid in the pesticide tank which prevents backflow of pesticide liquids into the water source. The air gap should be a minimum of 2 times the diameter of the filling hose or pipe.

airblast sprayer. A sprayer that uses a high-powered fan to carry spray droplets to target surfaces. Airblast sprayers are usually used on tall plants such as trees or vines.

application frequency restriction. A limitation on the number of times a particular pesticide may be applied to the same crop in a growing season.

application pattern. The course the applicator follows through the area being treated with a pesticide.

aquifer. An underground formation of sand, gravel, or porous rock that contains water. The place where groundwater is found.

back siphoning. The process that permits pesticide-contaminated water to be sucked from a spray tank back into a well or other water source. Back siphoning is prevented by providing an air gap or double check valve (backflow prevention device) in the pipe or hose used to fill a spray tank.

backflow. See *back siphoning*.

belly grinder. A hand operated device used to apply pesticide granules. The device straps to the front of the operator, who then turns a crank while walking forward through the treatment area.

beneficial. Pertaining to being helpful in some way to people, such as a beneficial plant or insect.

biological control. The action of parasites, predators, pathogens, or competitors in maintaining another organism's density at a lower average than would occur in their absence. Biological control may occur naturally in the field or be the result of manipulation or introduction of biological control agents by people.

biology. Knowledge about the life habits of a plant or animal.

boom applicator. A pesticide application device having multiple nozzles spaced along a boom, making it possible to spray a wide swath. Boom applicators are usually used for herbicide application and for other pesticides in field and row crops.

brand name. The registered or trade name given to a pesticide by its manufacturer or formulator. A specific pesticide may be sold under several brand names.

buffer. A chemical substance capable of neutralizing acid and base solutions to maintain a constant pH. Often used in spray mixtures.

buffer strip. An area of a field left unsprayed for the purpose of protecting nearby structures or sensitive areas from drift. The minimum buffer strip is usually one swath width.

calibration. The process of measuring pesticide applicator output, travel speed, swath width, and capacity to enable application of pesticides at the proper rate.

cardiopulmonary resuscitation (CPR). A procedure designed to restore normal breathing after breathing and heartbeat has stopped.

caution. The signal word used on labels of pesticides having the least capacity for hazards. These pesticides

have an oral LD₅₀ greater than 500 and a dermal LD₅₀ greater than 2000.

certified applicator. A person who has demonstrated through an examination process the ability to safely handle and apply highly hazardous restricted-use pesticides.

certified private applicator. A farm owner or responsible person employed by a farming operation who has demonstrated through an examination process the ability to safely handle and apply restricted-use pesticides on the farm property under their control.

chemical name. The official name given to a chemical compound to distinguish it from other chemical compounds.

CHEMTREC. A chemical industry-supported organization that provides assistance and advice on cleaning up pesticide emergencies. The telephone number of CHEMTREC is 1-800-424-9300.

chlorinated hydrocarbon. Also known as organochlorines, were frequently used for insect and mite control, although most early forms of these compounds have now been banned due to environmental persistence or other problems. DDT, chlordane, toxaphene, and dieldrin

- are examples of some of the earlier-developed chlorinated hydrocarbons.
- chronic illness.** An illness that will last for long periods of time. Cancer, respiratory disorders, and neurological disorders are examples of chronic illnesses that have been associated with exposures to some types of pesticides.
- chronic onset.** Symptoms of pesticide poisoning that occur days, weeks, or months after the actual exposure.
- Class 1 disposal site.** A disposal site for toxic and hazardous materials such as pesticides and pesticide-contaminated wastes.
- Class 2 disposal site.** A disposal site for nontoxic and nonhazardous materials such as household and commercial waste. Sanitary landfills are class 2 disposal sites. Some class 2 disposal sites have special hazardous materials disposal areas
- closed mixing system.** A device used for measuring and transferring liquid pesticides from their original container to the spray tank. Closed mixing systems reduce chances of exposure to concentrated pesticides. Closed mixing systems are required when mixing liquid pesticides with the signal word *danger*.
- common name.** The recognized, nonscientific name given to plants and animals. Many pesticides also have common names, separate from their brand names and chemical names.
- confined area.** An area, such as a building or greenhouse, that may have restricted air circulation and therefore promote the buildup of toxic fumes or vapors from a pesticide application.
- corrosive materials.** Certain chemicals that react with metals or other materials. Some pesticides are corrosive and special handling requirements are needed when using these.
- county Agricultural Commissioner.** The official in each county in California that has the responsibility for enforcing the state and federal pesticide regulations and issuing permits for restricted-use pesticides. County Agricultural Commissioners and their staff frequently inspect pesticide applications and application sites and investigate pesticide illnesses and environmental exposures. All agricultural uses of pesticides must be reported monthly to county Agricultural Commissioners.
- danger.** The signal word used on labels of pesticides having serious health and environmental hazards. This signal word is used on pesticides having an oral LD₅₀ less than 50 or a dermal LD₅₀ less than 200.
- deactivation.** The process by which the toxic action of a pesticide is reduced or eliminated by impurities in the spray tank, by water being used for mixing, or by biotic or abiotic factors in the environment.
- deficient oxygen condition.** A condition where the oxygen concentration in air falls below 19%, thus making an area highly hazardous. High levels of pesticide vapors in a confined area can displace oxygen, creating a deficient oxygen condition. Supplied air respirators (SCBAs) are required to be worn when entering areas with deficient oxygen conditions.
- deposition.** The placement of pesticides on target surfaces.
- deposition aid.** An adjuvant that improves the ability of a pesticide spray to reach the target.
- diluent.** The inert liquid or powdered material that is combined with the active ingredient during manufacture of a pesticide formulation. Also, the water, petroleum oil, or other liquid in which the formulated pesticide is mixed before application.
- directions for use.** The instructions found on pesticide labels indicating the proper procedures for mixing and application.
- disposal site.** See *Class 1 disposal site* and *Class 2 disposal site*.
- dose.** The measured quantity of pesticide. Often the size of the dose determines the degree of effectiveness, or, in the case of poisoning of nontarget organisms, the degree of injury.
- drift.** The movement of pesticide dust, spray, or vapor away from the application site.
- early-entry worker.** An employee who enters a pesticide application site to perform cultural activities before the expiration of the restricted-entry interval. Special employer requirements must be addressed before allowing early entry.
- emergency exemption from registration.** A federal exemption from regular pesticide registration sometimes issued when an emergency pest situation arises for which no pesticide is registered that has a tolerance on the crop in question.
- emulsifiable concentrate.** A pesticide formulation consisting of a petroleum-based liquid and emulsifiers that enable it to be mixed with water for application.
- endangered species.** Rare or unusual living organisms whose existence is threatened by people's activities, including the use of some types of pesticides.
- environmental contamination.** Spread of pesticides away from the application site into the environment, usually with the potential for causing harm to organisms.
- establishment number.** A number assigned to registered pesticides by the US Environmental Protection Agency which indicates the location of the manufacturing or formulation facilities of that product.
- exposure.** The unwanted contact

with pesticides or pesticide residues by people, other organisms, or the environment.

fieldworker. An employee of a farming operation who performs cultural practices on crops or agricultural soil.

fieldworker training. Specific training mandated by the US Environmental Protection Agency and the state of California to assist fieldworkers in protecting themselves from pesticide residues when they work in areas that have received pesticide applications. Training is required if fieldworkers enter areas during a 30-day period after the expiration of a restricted-entry interval.

first aid. The immediate assistance provided to someone who has received an exposure to a pesticide. First aid for pesticide exposure usually involves removal of contaminated clothing and washing the affected area of the body to remove as much of the pesticide material as possible. First aid is not a substitute for competent medical treatment.

flow rate. The amount of pesticide being expelled by a pesticide sprayer or granule applicator per unit of time.

flowable. Flowable formulations consist of finely ground particles of pesticide active ingredient mixed with a liquid, along with emulsifiers, to form a concentrated emulsion. These liquids are mixed with water

for dilution prior to spraying.

formulation. A mixture of active ingredient combined during manufacture with inert materials. Inert materials are added to improve the mixing and handling qualities of a pesticide.

fume. The vapor phase of some pesticide active ingredients.

fumigant. Vapor or gas form of a pesticide used to penetrate porous surfaces for control of soil dwelling pests or pests in enclosed areas or storage facilities.

groundwater. Fresh water trapped in aquifers beneath the surface of the soil; one of the primary sources of water for drinking, irrigation, and manufacturing.

hand lens. A small magnifying glass used in monitoring for plant pests.

handler. A person who mixes, loads, or applies pesticides, or who cleans or repairs contaminated equipment, works as a flagger, or handles unsealed pesticide containers.

hazard communication. Part of California's pesticide regulations that requires employers to provide information about pesticides and pesticide applications at the workplace. See Pesticide Safety Information Series A8 and A9 for more information.

hazardous materials. Materials,

including many pesticides, which have been classified by regulatory agencies as being harmful to the environment or to people. Hazardous materials require special handling and must be stored and transported in accordance with regulatory mandates.

hazardous waste. A hazardous material for which there is no further use. Remains from pesticide spill cleanup are often hazardous wastes. Hazardous wastes can only be disposed of through incineration or by transporting to a Class 1 disposal site.

hydrolysis. A chemical process that involves incorporating a water molecule into another molecule.

hygiene. As it applies to pesticide exposure, hygiene involves washing exposed body areas promptly to remove pesticide residues.

illegal residues. Remains of a pesticide or its breakdown products on a crop when that pesticide has not been legally registered for use on that crop.

incompatibility. A condition in which two or more pesticides are unable to mix properly or one of the materials chemically alters the other to reduce its effectiveness or produce undesirable effects on the target.

incompatible mixture. The result when two or more pesticides are combined and they react to make the mixture unusable.

inversion. A weather phenomenon

in which cool air near the ground is trapped by a layer of warmer air above. Vapors of pesticides applied during an inversion condition can become trapped and concentrated and move away from the treatment area with the potential to cause damage or injury at some other location.

irreversible injury. A health condition caused by certain exposures to some pesticides in which there is no medical treatment or recovery.

labeling. The pesticide label and all associated materials, including supplemental labels, special local needs registration information, and manufacturer's information.

LC₅₀. the lethal concentration of a pesticide in the air or in the body or water that will kill half of a test animal population. LC₅₀ values are given in micrograms per milliliter of air or water ($\mu\text{g}/\text{ml}$).

LD₅₀. the lethal dose of a pesticide, applied to the skin or taken internally, that will kill half of a test animal population. LD₅₀ values are given in milligrams per kilogram of test animal body weight (mg/kg).

leaching. The process by which some pesticides move down through the soil, usually by being dissolved in water, with the possibility of reaching groundwater.

life stage. The development stages living organisms pass through over

- time. Plants and animals (especially insects) pass through several life stages during which their susceptibility or tolerance to pesticides vary.
- long-term health problem.** A pesticide-related illness or disease which may extend over months, years, or a lifetime.
- medical facility.** A clinic, hospital, or physician's office where immediate medical care for pesticide-related illness or injury can be obtained.
- mixing.** The process of opening pesticide containers, weighing or measuring specified amounts, and transferring these materials into application equipment, all in accordance with instructions found on pesticide labels.
- monitoring.** The process of carefully watching the activities, growth, and development of pest organisms over a period of time, often utilizing very specific procedures and monitoring aids.
- monthly pesticide use report.** A form which must be completed and submitted to the local Agricultural Commissioner's office by the tenth of the month following any month in which pesticides are applied to an agricultural crop.
- MSDS.** A Material Safety Data Sheet that provides information relating to hazards and chemical characteristics of pesticides.
- natural enemy.** An organism that causes premature death of a pest organism; includes predators, pathogens, parasites, and competitors.
- nonpoint pollution source.** Pollution from pesticides or other materials that arises from their normal or accepted use over a large general area and extended period of time.
- nontarget organism.** Animals or plants within a pesticide treated area that are not intended to be controlled by the pesticide application.
- offsite movement.** Any movement of a pesticide from the location where it was applied. Offsite movement occurs through drift, volatilization, percolation, water runoff, crop harvest, blowing dust, and by being carried away on organisms or equipment.
- output rate.** The amount of pesticide mixture discharged by pesticide application equipment over a measured period of time. The usual output rate for liquid sprayers is measured in gallons per minute.
- personal hygiene.** See *hygiene*.
- personal protective equipment.** Devices and garments that protect people from exposure to pesticides. These include coveralls, eye protection, gloves and boots, respirators, aprons, and hats.
- Pest Management Guidelines.** A series of crop-related publications from the University of California that provide research-based information on managing pests through chemical and nonchemical means. These guidelines are available through county University of California Cooperative Extension Service offices and can be accessed on the world wide web at: <http://www.ipm.ucdavis.edu>.
- pesticide.** Any substance or mixture of substances intended for preventing, destroying, repelling, or mitigating any insects, rodents, nematodes, fungi, or weeds, or any other forms of life declared to be pests; and any other substance or mixture of substances intended for use as a plant regulator, defoliant, or desiccant.
- pesticide deposition.** See *deposition*.
- pesticide handler.** See *handler*.
- pesticide resistance.** Genetic qualities of a pest population that enable individuals to resist the effects of certain types of pesticides that are toxic to other members of that species.
- pesticide use hazard.** The potential for a pesticide to cause injury or damage during handling or application.
- pH.** A measure of the concentration of hydrogen ions in a solution—as the number of hydrogen ions increase, the solution becomes more acid.
- pheromone.** A chemical produced by an animal to attract other animals of the same species.
- phytotoxic.** Injurious to plants.
- plantback restriction.** A restriction which limits the type of commodity that can be grown in an area for a designated period of time after a certain pesticide has been used.
- point pollution source.** Pollution of the soil or groundwater caused by spilling or dumping quantities of a toxic material in one location.
- post application cleanup.** Washing of application equipment, personal protective equipment, and other items used during a pesticide application to remove pesticide residues.
- PPE.** See *personal protective equipment*.
- precautionary statement.** The section on pesticide labels where human and environmental hazards are listed; personal protective equipment requirements are listed here as well as first aid instructions and information for physicians.
- preharvest interval.** A period of time as set by law that must elapse after a pesticide has been applied to an edible crop before the crop can be harvested legally. Pesticide labels provide information on preharvest intervals.
- pressure.** The amount of force applied by the application equipment pump on the liquid pesticide mixture to force it through the nozzles.
- pressure gauge.** An instrument on liquid pesticide application equipment that measures the pressure of the liquid being expelled.

private applicator. Individuals who apply pesticides on agricultural property under their control and for their own benefit or needs.

protective clothing. Garments of personal protective equipment that cover the body, including arms and legs.

registrant. Company that obtained the registration of the pesticide product; also referred to as the manufacturer of the formulated product

registration number. Identification numbers assigned by the US Environmental Protection Agency and the California Department of Pesticide Regulation and found on pesticide labels.

regularly handle. The employee handles pesticides during any part of the day for more than six calendar days in any 30 day consecutive period. Any day spent loading pesticides while exclusively using a closed system or mixing only pesticides sealed in water-soluble packers is not included in the six day period if the employee has a baseline blood cholinesterase level established under a medical supervision program.

rescue breathing. Artificial respiration, given mouth-to-mouth, to assist or restore breathing to a person overcome by pesticides. Rescue breathing is given if the victim has a pulse.

residue. Traces of pesticide that remain on treated surfaces after a period of time.

respiratory equipment. A highly specialized device that filters out pesticide dusts, mists, and vapors to protect the wearer from air exposure during mixing and loading, application, or when entering treated areas. Also known as a respirator.

restricted materials permit. A permit, issued by county Agricultural Commissioner offices, that enable growers to possess and apply restricted-use pesticides. Restricted materials permits can only be issued to certified applicators.

restricted-entry interval. A period of time that must lapse between application of a pesticide and when it is safe to allow people into the treated area without requiring they wear personal protective equipment and receive early-entry worker training.

restricted-use pesticide. Pesticides that can only be possessed or used by people who are qualified as certified applicators.

These pesticides require a permit from the agricultural commissioner (for possession, purchase, or use).

reversible injury. A pesticide-related injury (or illness) that can be reversed through medical intervention or the body's healing process.

route of exposure. The way a pesticide gets onto or into the body. The four routes of exposure are dermal (on or through the skin), ocular (on or in the eyes), respiratory (into the lungs), and ingestion (through swallowing).

ruffling. Spray applied with oscillating motion or an air blast so the droplets come in contact with all of the target plant's leaf surfaces.

run off. The process by which some pesticides move with surface water with the possibility of contaminating bodies of fresh water, such as rivers.

service container. Any container that holds a pesticide other than the original packaging. Service containers require labeling with signal word, name of material, and responsible person (name and address).

shingling. Spray that is applied in such a way that the leaves of the target plant are pressed together and the droplets cannot reach all surfaces.

sight gauge. A device on the outside of a pesticide sprayer or a configuration of the spray tank that permits the operator to view the level of liquid in the tank without opening the lid.

signal word. One of three words (danger, warning, caution) found on every pesticide label to indicate the relative hazard of the chemical.

site. The area where pesticides are applied.

skin absorption. The passage of pesticides through the skin into the bloodstream or other organs of the body.

special local needs registration. A state registration for additional uses or adding limitations for a federally-registered pesticide (also known as a 24c)

speed of travel. The speed that the operator moves the pesticide application equipment through the area being treated. It is necessary to calculate the speed of travel in order to calibrate pesticide application equipment.

spray check device. A special piece of equipment that measures and visualizes the output from the nozzles on a spray boom. This device provides rapid visualization of differences in output between nozzles.

statement of use classification. A special statement found on labels of some highly hazardous pesticides indicating their use is restricted to people who are qualified through a certification process.

supplemental label. Additional instructions and information that are not found on the pesticide label because the label is too small, but is considered to be part of the pesticide labeling.

supplied air respirator. A tightly-fitting face mask that is connected by hose to an air supply such as a tank worn on the back of the person

- using the respirator or to an external air supply. Supplied air respirators permit people to enter oxygen-deficient areas or areas where there are highly toxic pesticide vapors.
- surface water.** Water contained in lakes or ponds or flowing in streams, rivers, and canals.
- susceptible life stage.** The life stage of a pest organism which is most susceptible to a pesticide used to control it. In general, insects are most susceptible during the larval or juvenile stages; weeds are usually most susceptible during the seedling stage.
- swath width.** The width of the area covered by spray droplets or granules as the application equipment moves through. The swath width must be measured to calibrate application equipment.
- symptom.** Any abnormal condition caused by a pesticide exposure that can be seen or felt or that can be detected by examination or laboratory tests.
- temperature inversion.** See *inversion*.
- threshold.** A point at which the value of the damage caused by a pest exceeds the cost of controlling the pest, therefore it becomes practical to use the control method. Also known as economic threshold.
- toxicity.** The potential the pesticide has for causing harm.
- training record.** The document, signed by the trainer, employer, and trainee, to record the dates and types of pesticide safety training received.
- treated surface.** The surface of plants, soil, or other items that were contacted with pesticide spray, dust, or granules for the purpose of controlling pests.
- treatment area.** See *sitc*.
- triple rinse.** The process of partially filling an empty pesticide container, replacing the lid, shaking the container, then emptying its contents into the spray tank. This procedure is performed three times to assure that most of the pesticide residue is removed. Triple rinsed containers can be offered for special pesticide container recycling or taken to a Class 2 disposal site.
- volatilization.** The process of a pesticide liquid (or solid) passing into a gaseous stage.
- warning.** The signal word used on labels of pesticides having an oral LD₅₀ between 50 and 500 and a dermal LD₅₀ between 200 and 2000.
- water-soluble concentrate.** A type of pesticide formulation consisting of an active ingredient that will not dissolve in water, combined with a mineral clay and other inert ingredients and ground into a fine powder.
- wettable powder.** A type of pesti-
- cide formulation consisting of an active ingredient that will not dissolve in water, combined with a mineral clay and other inert ingredients and ground into a fine powder.
- work clothing.** Garments such as long-sleeved shirts, short-sleeved shirts, long pants, short pants, shoes, and socks. Work clothing is not considered personal protective equipment, although pesticide product labeling or regulations may require specific work clothing during some activities. Work clothing differs from and should not be confused with a coverall. While coveralls shall be provided by the employer, work clothing can be required to be provided by the employee. Short-sleeved shirts and short pants are considered acceptable work clothing only under conditions expressly permitted by pesticide product labeling.

INDEX

- A**
- 24(c). *See* Special Local Need Registrations
 - acidifier, using to adjust pH in water, 39
 - active ingredients, 23, 31
 - acute illness, 66
 - acute onset symptoms, defined, 65
 - adjuvants, 39
 - airblast sprayer, 43
 - air gap, 42-43, Fig. 2-5
 - algae in water, 39
 - alkaline water, 39
 - amount of pesticide to use, determining, 56
 - pesticide label, rate per acre, 56
 - angering easily, as symptom of
 - heat related illness, 67
 - anxiety, as symptom of pesticide poisoning, 66
 - application, pesticide. *See* pesticide application, restrictions; pesticide application, safe and effective application equipment, selecting, 43-44, Fig. 2-7
 - application frequency, restrictions, 19
 - application pattern, 45-46, Fig. 2-9
 - and uneven application, 46
 - buffer strips, 46
 - purpose, 46
 - application speed, 46
 - apprehension, as symptom of pesticide poisoning, 66
 - aquifers, defined, 7, Fig. 3-7
 - area to be treated, determining, 56
 - circles, formula for measuring, 56
 - irregular shapes, formula for measuring, 56
 - squares or rectangles, formula for measuring, 56
 - triangles, formula for measuring, 56
- B**
- backpack sprayers, 53, 54
 - back siphoning, preventing, 42-43
 - belly grinder, 58
 - beneficial insects, 9
 - protection of, 9
 - beneficial organisms, 9, 14
 - beneficial species, 15, 73
 - purchasing, 15
 - biological control, disruption, 63
 - birds, injury to, 63
 - blistered skin, as symptom of pesticide poisoning, 66
 - blurred vision, as symptom of pesticide poisoning, 66
 - brand name, on pesticide label, 23
 - buffers, using to adjust pH in water, 39
 - buffer strips, 46
- C**
- calibrating application equipment, 48-62
 - amount of pesticide to add, determining, 48, 49
 - calibration information sheet, 50
 - granular equipment, 58-59 (*see also* granular application equipment, Calibrating)
 - liquid equipment, 49-57
 - abrasive pesticides, 49
 - collection method, hand-held sprayers, 53-54
 - collection method, low-pressure sprayers, 53-54
 - determining amount of pesticide to use, 56
 - determining area to be treated, 56
 - high-pressure sprayers, 54-55
 - measuring flow rate, 53-55
 - measuring speed of travel, 52-53
 - measuring tank capacity, 51-52
 - pump and nozzle wear, 49
 - speedometers vs. actual speed, 52
 - spray check devices, 55
 - calibration
 - spray swath, measuring width of, 55, Fig. 2-12
 - wearing protective equipment, 49
 - calibration, 48-59
 - and effective pest control, 48
 - and environmental concerns, 48
 - and human health, 48
 - and legal considerations, 49
 - and prevention of waste, 49
 - and protection of treated plants, 48-49
 - defined, 48
 - flow meter, 51
 - importance of, 48
 - over-application, resulting problems, 48
 - under-application, resulting problems, 48
 - calibration worksheet, 50
 - cardiopulmonary resuscitation, training, 79
 - cartridge respirator, 41
 - inspecting and cleaning, 68
 - cat litter, for pesticide cleanup, 84
 - caution, signal word, 25
 - certification
 - of commercial applicators, 2
 - of private applicators, 2
 - certified private applicator, 2
 - chemical name, on pesticide label, 23
 - chemical properties; pesticides, 31
 - CHEMTREC, 74
 - chlorinated hydrocarbons, 70
 - cholinesterase testing, 12
 - chronic illness, 66
 - chronic onset symptoms, defined, 65-66
 - class 1 disposal site, 83
 - class 2 disposal site, 42
 - closed mixing system, 40, Fig. 2-2
 - Commercial Applicator Certification, 2
 - common name, on pesticide label, 23
 - compressed air strainers, 54
 - confusion, as symptom of heat related illness, 67
 - contamination, groundwater, 70-72
 - contamination, surface water, 72
 - contents, on pesticide label, 23
 - convulsions, as symptom of pesticide poisoning, 66
 - county Agricultural Commissioner, 1, 2-4, 14, 22, 27, 30, 38, 47, 74, 83-86
 - CPR. *See* cardiopulmonary resuscitation
 - creeks, contamination hazards, 7
 - crop stage, pesticide application
 - restrictions, 19
 - cultural control practices, 15

D

 - danger, signal word, 25
 - dealers, unlicensed, 16
 - Department of Transportation, U.S., notification, 34
 - shipping name, 34
 - diarrhea, as symptom of pesticide poisoning, 66
 - dipstick, calibrated, marking and using, 51, 55
 - directions for use, pesticide label, 25-26
 - agricultural use requirements, 25
 - harvest interval, 26
 - livestock, restrictions on feeding crop residues, 26
 - personal protective equipment, 25
 - plantback restrictions, 26
 - restricted-entry interval, 25, Fig. 1-5
 - storage and disposal, 26
 - target pests, 26
 - Worker Protection Standard, 25-27
 - disposal, safe
 - of empty pesticide bags and containers, 10, 22
 - of pesticide wastes, 10, 72
 - of unused pesticide, 22-23
 - preventing environmental contamination, 22
 - preventing hazards to people, 22
 - disposal site. *See* class 1 disposal site; class 2 disposal site
 - dizziness, as symptom of pesticide poisoning, 66
 - drift. *See* pesticide drift
 - droplet size and deposition, controlling, 45
 - dust/mist respirator, 41

- E**
- early-entry workers, 27-28
 - special training and PPE, 28
 - emergency medical care program, 12
 - emergency medical facility, 12
 - emergency plan, 13
 - first aid supplies, 13
 - for handling spills, 13
 - information about pesticides in use, 13
 - response agencies, 13
 - spill cleanup kits, 13
 - telephone numbers, emergency, 12
 - training in first aid procedures, 13
 - emergency telephone numbers, 12
 - endangered species, 20
 - enforcement, in California, 2
 - environmental contamination, 19, 63, 70-72, Fig. 3-6
 - drift, 70, 72
 - label warnings, 19
 - leaching and runoff, 70-72
 - nontarget species, 70, 72-74
 - persistence of residues, 70
 - environmental hazards, 19
 - checking application site for, 45
 - establishment number, on pesticide label, 23
 - exposure. *See also* pesticides, personal exposure
 - effects of, 65-66
 - routes of, 1, Fig. 1-4
 - eye, nose, and throat irritation, as symptom of pesticide poisoning, 66
- F**
- faceshield, 41, 69
 - fainting, as symptom of heat related illness, 67
 - Farm Profile, 3, 4-20
 - Federal Insecticide, Fungicide, and Rodenticide Act, 26
 - federal registration number, 23
 - federal Worker Protection Standard. *See* Worker Protection Standard
 - fieldworker training. *See also* training and protection, worker
 - FIFRA. *See* Federal Insecticide, Fungicide, and Rodenticide Act
 - filling hose, 51
- G**
- germicidal cleaners, using for respirators, 68
 - gloves, 41, 68
 - goggles, 41, 69
 - granular application equipment, calibrating, 58-59
 - application rate, determining, 58
 - rate of output, measuring, 58-59
 - size and shape of granules, 58
 - swath width, measuring, 59
 - travel speed, measuring, 58; Fig. 2-10
 - groundwater contamination, 7, 70-72
 - factors influencing, 71
 - leaching, defined, 71
 - nonpoint pollution, 71, Fig. 3-7
 - point pollution, 71, Fig. 3-7
 - laws, stringent California, 71
 - pesticide residues in California wells, 70
 - potential for, 7
 - preventing, 70-72
 - unsafe drinking water, 70
 - Groundwater Protection Areas, defined, 7
- H**
- fires, pesticide, 14. *See also under* pesticide emergencies
 - first aid, 65, 78-82
 - cardiopulmonary resuscitation and, 80, 81
 - courses, American Red Cross, 79
 - decontamination, 79
 - determined by type of exposure, 78
 - label, precautionary statements, 78
 - protecting yourself while administering, 79
 - steps for eye exposure, 80, Fig. 4-4
 - steps for heat related illness, 67
 - steps for inhalation, 81
 - steps for skin exposure, 79-80, Fig. 4-3
 - steps for swallowed pesticides, 82
 - flammable liquid pesticides, 83
 - flow rate
 - defined, 53
 - measuring, 53-55
 - high-pressure sprayers, 54-55, Fig. 2-11
 - manufacturer's charts, 53
 - nozzle wear, 53, 54
 - rechecking after changing nozzles, 54
 - formulation, on pesticide label, 23
- H**
- handler. *See* pesticide handler, defined; pesticide handler training
 - hard water, 39
 - hazard, pesticide, 1. *See also* pesticide hazards, recognizing and avoiding
 - Hazard Communication Standard, OSHA, 31
 - headache
 - as symptom of heat related illness, 67
 - as symptom of pesticide poisoning, 66
 - health problems
 - long-term, 31, 63
 - short-term, 63
 - heat related illness, 67, 107-108
 - and California training regulations, 66-67
 - and PPE, 67
 - avoiding, 67, 107-108
 - first aid, 67, 107-108
 - symptoms of, 67, 107-108
 - heavy sweating, as symptom of pesticide poisoning, 66
 - high-pressure sprayers, 54-55, Fig. 2-11
 - honey bees, 9, 45, 47, 48, 63, 73
 - human health, impacts of pesticide handling, 63
 - hydraulic agitators, calibration and, 53
 - hydrolysis, 39
- I**
- illegal application, crop not on label, 16
 - illegal residues. *See under* pesticide residues
 - Illustrated Guide to Pesticide Safety*, 10
 - inert ingredients, 23
 - ingredients, on pesticide label, 23
 - injuries, 64-66
 - inversion. *See* temperature inversion
 - IPM Manuals, 5, 6, 9, 15
 - labeling. *See* pesticide label; pesticide label, parts of
 - laws and regulations, for pest control operations, 1
 - LC₅₀, defined, 30
 - LD₅₀, defined, 30
 - leaching. *See under* groundwater contamination; environmental contamination
 - liquid tank capacity, measuring, 51
- I**
- long-term health problem. *See* chronic illness
 - low-pressure boom sprayers, 53
- M**
- manufacturer, on pesticide label, 23
 - measuring pesticides, 39-41
 - calibrated measuring utensils, 40, Fig. 2-3
 - medical monitoring program, 12
 - posting, 12
 - medical treatment, 65, 79
 - methods of control, combining, 14-15
 - mixing and applying pesticides, 38-62, Fig. 2-1
 - mixing pesticides, 38-43, Fig. 2-1
 - recognizing and avoiding hazards, 63
 - steps for, 42-43
 - water, for spray tank, 51
 - wearing protective clothing, 49-51
 - mixing systems, closed, 40
 - legal requirements, exceptions, 40
 - monitoring. *See* pest monitoring
 - Monthly Pesticide Use Report, 1
 - MSDSs, 13, 14, 30-34, Fig. 1-7
 - fire fighting information, 84
 - sample MSDS, 32-33
 - spills, cleanup information, 31, Fig. 1-8
- N**
- N-methyl carbamate pesticides, 12
 - natural enemies, 73. *See also* beneficial species
 - destruction, 9, 63, 73
 - purchasing, 15
 - nausea
 - as symptom of pesticide poisoning, 66
 - as symptom of heat related illness, 67
 - nonpoint pollution. *See under* groundwater contamination
 - nonpoint organisms, 47, 48, 70
 - defined, 72
 - Pest Management Guidelines*, using, 73
 - pesticide impact on, 72-74
 - wildlife, 73, Fig. 3-9
 - nontarget vegetation, 63
 - notification, employee
 - California regulations, 28
 - oral, 28
 - posting, 28

- nozzles
 - and calibration, 48-57
 - and droplet size, 45, 47
- O**
 - OES. See Office of Emergency Services, State of California
 - Office of Emergency Services, State of California, 82
 - offsite movement. See pesticide drift
 - operating pressure range, 53
 - and flow rate, 53
 - organophosphate pesticides, 12
 - oscillating boom sprayer, 43
 - overuse of pesticides, 63
- P**
 - penalties for violations, in California, 2
 - permit, restricted-use, 2-3
 - personal hygiene, 67-68, Fig. 3-3
 - employer responsibilities and requirements, 67-68
 - personal protective equipment. See also under mixing pesticides; precautionary statements
 - and heat related illness, 67
 - cleaning and maintaining, 68-70, Fig. 3-5
 - employer responsibilities, 68-70
 - faceshields, 69
 - goggles, 69
 - respirators, 68
 - rubber boots and gloves, 68-69, Fig. 3-4
 - safety glasses, 69
 - storage, 69-70
 - used protective clothing and coveralls, 69, Fig. 3-5
 - waterproof protective clothing, 69
 - Pest Control Dealers, DPR-licensed, 16
 - application timing, life stages, 47
 - nontarget organisms, 47-48
 - nontarget plants, 47
 - Pest Management Guidelines*, 5, 6, 9, 15, 73
 - pest management program, developing, 14-15
 - pest monitoring, 5-6, 14
 - pest resistance, 63
 - pesticide absorption, rate of, 65
 - pesticide application, safe and effective, 43-48
 - air blast sprayer, 43, Fig. 2-6
 - application pattern, 45-46, Fig. 2-9
 - application speed, 45
 - calibration, 43
 - clothing (see personal protective equipment)
 - coverage, 43, Fig. 2-6
 - drift, 43, 46-47
 - droplet size and deposition, controlling, 45
 - environmental hazards, checking the site, 45
 - good techniques, 43
 - heat related illness, 67, 107-108
 - leaks, 43
 - oscillating boom sprayer, 43
 - proper equipment, 43-44
 - ruffing, 43, Fig. 2-6
 - shingling, 43, Fig. 2-6
 - spills, 43
 - weather, 44-45
 - pesticide containers, handling, 74
 - diluted vs. undiluted pesticides, risk, 74, 78, 82
 - spills during transport, 74, 82
 - pesticide deposition, uneven, 46
 - pesticide disposal, 72
 - pesticide drift, 43, 46-47, 63, 72
 - defined, 46
 - evaporation, 47
 - reducing, 47
 - wind speed, legal considerations, 47
 - windy conditions, 47
 - pesticide emergencies, 78-87, Fig. 4-1. See also first aid
 - emergency medical care, professional, 79
 - emergency medical information, posting, 78, Fig. 4-2
 - heat related illness, 67, 107-108
 - leaks and spills, 82-84, (see also pesticide leaks or spills, cleaning up)
 - cleanup and disposal, 83-84
 - emergency, always treating as, 82
 - on cleanable surfaces, 83, 84
 - on public roadways, 82
 - required reporting to authorities, 82-83
 - misapplication of pesticides, 85-86
 - accidental, defined, 85
 - incorrect amount, what to do, 85-86
 - intentional, defined, 85
 - negligent, defined, 85
 - responsibilities, financial and legal, 85
 - wrong pesticide what to do, 86
 - wrong site, what to do, 86
 - pesticide fires, 84-85
 - decontaminating equipment and clothing, 84
 - fighting, 84
 - steps for dealing with, 84-85
 - toxic fumes and smoke, 84
 - water, using with caution, 84
 - pesticides in eyes, 80, Fig. 4-4
 - pesticides inhaled, 81
 - potential sources, 81
 - supplied air respirator, using for rescue, 81
 - pesticides on skin or clothing, 79-80
 - pesticides, swallowed, 82
 - pesticide fires, 14. See also under pesticide emergencies
 - consulting Material Safety Data Sheets, 14
 - pesticide handler, defined, 10, 27
 - pesticide handler training, 10, 66-67
 - California requirements, 10, 66-67
 - Pesticide Hazard Communication Program, California, 11
 - pesticide hazards, recognizing and avoiding, 63-77, Fig. 3-1
 - pesticide injuries
 - reducing severity, 65
 - types of, 65-66
 - acute onset, 65
 - chronic onset, 65-66
 - irreversible, 66
 - reversible, 66
 - pesticide label. See also pesticide label, parts of
 - as a legal document, 21, Fig. 1-1
 - comparing before purchasing, 16
 - environmental contamination, warnings, 19
 - finding information on, 22
 - learning to use, 22
 - legal penalties for violating, 21
 - other documents as part of, 21
 - phytoxicity, warnings, 18
 - plantback restrictions, 18
 - precautionary statements, pesticide hazards, 17
 - preharvest interval, 17
 - restricted-entry interval, 17, Fig. 1-5
 - sample label, 24
 - samples, obtaining, 16
 - supplemental labels, 21
 - when to read, 22
 - before disposing of empty containers, 22
 - before disposing of unused pesticide, 22
 - before mixing and applying, 22
 - before purchasing, 22
 - when storing, 22
 - pesticide label, parts of, 23-26
 - active ingredients, 23
 - brand name, 23
 - chemical name, 23
 - classification, 23, 25
 - common name, 23
 - contents, 23
 - directions for use, 25-26
 - formulation, 23
 - inert ingredients, 23
 - manufacturer, 23
 - precautionary statements, 25
 - registration and establishment numbers, 23
 - signal words and symbols, 25, Fig. 1-3
 - pesticide leaching. See under groundwater contamination; environmental contamination
 - pesticide leaks or spills, cleaning up, 83-84
 - major, 83
 - small, basic steps, 83-84
 - pesticide mixing location, considerations, 41
 - pesticide packaging, preweighed amounts, 41, Fig. 2-4
 - pesticide poisoning, common symptoms, 65-66
 - pesticide powders, potential for explosion, 83

- pesticide product registration, US EPA, 28-30
- pesticide regulations, 1
- pesticide regulatory program, in California enforcement, 2
- penalties, 2
- pesticide residues, 18, 64
- avoiding hazardous, 64
- avoiding spills, 64
- dormancy, 64
- pesticide selection, 64
- preventing siphoning, 64
- proper calibration, 64
- timing, placement, and rate of application, 64
- using cultural practices, 64
- importance and need for, 64
- influences on levels, 64
- undesirability, reasons, 64
- pesticide runoff, 70-72
- Pesticide Safety Information Series, 4, 10, 11, 22, 28, 105
- pesticide spills, 83-84
- pesticide storage, 10, 71
- pesticide wastes, safe disposal, 10, 71-2
- pesticides, agricultural-use, in California registration with DPR, 29, Fig. 1-6
- sale only by DPR-licensed dealers, 16, 29
- use of unregistered pesticides, 16, 29
- pesticides, mixing and applying. *See* mixing and applying pesticides
- pesticides, personal exposure
- how people are exposed, 64-65, Fig. 3-2
- single or repeated exposure, 65
- pesticides, physical properties, 31
- pesticides, preventing exposure, 66-70
- drift, preventing, 66
- handler, 66-67
- worker, 67-68
- pesticides, restricted-use, 1, 4, 23
- pesticides, selecting and purchasing, 16
- DPR-licensed Pest Control Dealers, 16
- guidelines, 16-20
- obtaining sample labels, 16
- unlicensed dealers, 16
- pesticides stored at your farm
- reporting requirements, 14
- pesticides, types, 16
- pesticides, unclassified, 23
- PH testing, 39
- phytotoxicity, 18, 44, 48, 63
- planning pesticide applications
- beneficial insects and organisms, considering, 9
- worker training, 10
- plantback restrictions, 18, 26
- point pollution. *See* *under* groundwater contamination
- poison information centers, regional, 82
- polypropylene tanks, 51
- port openings, 58, 59
- postapplication cleanup, 74-75
- cleaning contaminated application equipment, 75
- disposing of leftover pesticides, 74-75
- posting, emergency medical information, 12, 78
- power sprayers, 53
- PPE. *See* personal protective equipment
- precautionary statements
- acute injury, avoiding, 25
- delayed health effects, potential, 25
- environmental hazards, 25, 70-74
- first aid, 25
- human hazards, 25, 64-70, 78-83
- personal protective equipment, 25
- routes of entry, 25, Fig. 1-4
- sensitization, 25
- precautions against injury, 63
- preharvest interval, defined, 26
- pressure gauge, for calibration, 53
- preventing heat related illness, 67
- preventing exposure to pesticides. *See* pesticides, preventing exposure
- Private Applicator Certification, 2
- Private Applicator Certification Examination, 2, 3
- protective clothing for mixing and application, 39. *See also* *under* precautionary statements
- PPS. *See* Pesticide Safety Information Series
- R**
- Regional Water Quality Control Board, 84
- registration, pesticide product, 28-30
- skin rash, as symptom of pesticide poisoning, 66
- SUN. *See* Special Local Need registrations
- sloughs, contamination hazards, 7
- smoking and pesticide flammability, 83
- soda ash, use in detoxification, 83
- soil and water, 7
- soil maps, obtaining, 7
- soil types, identifying, 7
- Special Local Need registrations, 29
- speed of travel, measuring for liquid application equipment, 52-53, Fig. 2-10
- spray check devices, using, 55
- spray swath, measuring width of, 55, Fig. 2-12
- spray tanks, selecting, 43-44, Fig. 2-7
- sprayer output, changing, 56-57
- changing nozzle size, 57
- changing output pressure, 57, Fig. 2-13
- changing speed, 56-57
- reasons for, 56
- statement of use classification, 23
- restricted-use, 23
- unclassified, 23
- stomach pain, as symptom of pesticide poisoning, 66
- storage, safe
- of empty containers, 10, 22
- of pesticides, 10, 22, 71
- strange behavior, as symptom of heat related illness, 67
- supplemental labeling, for SUN registrations, 29
- surface water contamination, 72
- susceptible life stage, 47
- swath width, 55, 59
- sweating, as symptom of heat related illness, 67
- symptom, defined, 65
- symptoms of heat related illness, 67
- symptoms of pesticide exposure, 65-66
- acute onset, 65
- chronic onset, 65-66
- common symptoms, 66
- presence and severity dependent on dosage, 66
- variation among classes of pesticide, 66
- variation among pesticides within a class, 66
- registration in California, agricultural-use pesticides, 29
- emergency exemptions from registration, 29-30
- federal EPA registrations, 28-29
- registration number, 29
- Special Local Need registrations, SUN or 24(c), 29
- registration number, on pesticide label, 23
- regulations, pesticide, 1
- REI. *See* restricted-entry interval
- reporting, agricultural use of pesticides, 1
- residues, pesticide. *See* pesticide residues
- restlessness, as symptom of pesticide poisoning, 66
- restricted-entry interval, 11, 17, 27-28, Fig. 1-5
- restricted-use permit, 3, 4
- restricted-use pesticides, 1, 4, 23
- restricted-use statement, 23
- routes of exposure, 25, 30-31, Fig. 1-4
- ruffling. *See* *under* pesticide application, safe and effective
- S**
- Safe and Effective Use of Pesticides*, 4, 5, 6, 7, 8, 10
- sealable drum, for spill cleanup, 84, Fig. 4-6
- secondary pests, potential for outbreak, 9
- Section 18 Exemptions. *See* registration in California, agricultural-use pesticides
- selecting and purchasing pesticides, 16-20
- sensitivity to pesticides, variation among individuals, 65
- sensitization, 25
- shaking, as symptom of pesticide poisoning, 66
- shingling. *See* *under* pesticide application, safe and effective
- sight gauge, calibrating, 51
- signal words, on pesticide label, 25
- site considerations
- adjacent crops, 8
- environmental conditions, 8
- features of site, listing of, 8
- important structures, listing of, 8
- map of site, 8, 20
- sensitive areas, 8

T

temperature inversion, 44-45, 47, Fig. 2-8
 thirst, as symptom of pesticide poisoning, 66
 tiredness, as symptom of heat related illness, 67
 toxicity, 1
 training and protection, worker, 10-13, 67-68. *See also* Worker Protection Standard and label changes
 training requirements, California, 10-11
 travel speed, measuring, 52-53
 treated surfaces, damage, 63
 treatment area. *See* site considerations

U

UCCE Service. *See* University of California Cooperative Extension Service
UC IPM Pest Management Guidelines.
See Pest Management Guidelines
 unclassified pesticides, 23
 unconsciousness, as symptom of pesticide poisoning, 66
 University of California Cooperative Extension Service, 6, 15, 43
 unusual behavior, as symptom of pesticide poisoning, 66
 U.S. EPA establishment number, 23

V

volatilization, defined, 44
 vomiting, as symptom of pesticide poisoning, 66

W

warning, signal word, 25
 water contamination hazards
 creeks, 7
 other, 7
 sloughs, 7
 water quality damage, 63
 water-soluble packages, 41, Fig. 2-4
 weakness
 as symptom of pesticide poisoning, 66
 as symptom of heat related illness, 67
 weather, 8
 weather, pesticide application and, 27,

44-45, 46-47

website address, UC Statewide Integrated Pest Management Program, 6
 well casings, 71
 wildlife, damage to, 63. *See also under nontarget organisms*
 wind, 8. *See also* weather, pesticide application and
 worker protection. *See* training and protection, worker
 Worker Protection Standard, 25, 26, 27
 Worker Protection Standard and label changes, 25-28
 California regulation changes, 26-27
 early-entry workers, 27, 28
 handler and fieldworker training, 27
 maintaining application records, 27
 notification, oral, 28
 notification, posting, 28
 personal protective equipment, 27
 restricted-entry intervals, 27-28, Fig. 1-5
 worker training. *See* training and protection, worker
 WPS. *See* Worker Protection Standard;
 Worker Protection Standard and label changes